

Briton

2800 Series

Door controls



The Briton Overhead Concealed Transom Door Closer offers an aesthetically pleasing way to control door openings. The transom closer is suitable for a wide range of both interior and exterior applications including aluminum, timber and hollow metal doors and frames.

In addition to providing years of maintenance free operations, the Briton transom door closer range is easy to specify, order and install with other Allegion hardware.

Functional and practical the transom closer is suited to an array of commercial projects.

Features

- Adjustable spring strength 2-4 to suit door size and site conditions
- Durable cast iron construction ensures product longevity
- Heat treated forged steel piston
- Adjustable closing and latch speed
- Adjustment valves concealed behind transom cover
- Optional 90° and 105° hold open to ease accessibility
- Fits inside standard aluminium head section
- Side load arm standard

Warranties

Mechanical	10 years
------------	----------

Specification guide

Series	Function
Briton 2800 Series.....BNT-2800	Non hold open..... - Hold open 90° closer..... 90 Hold open 105° closer..... 105

- Series
Select the desired series e.g. Briton 2800 Series BNT-2800
- Function
Select hold open if required - omit for non hold open BNT-2800/90

Cover plate not included - specify separately

Selection chart

Strength	Maximum door width	Maximum door weight
2	850mm	40kg
3	950mm	60kg
4	1100mm	80kg

Finish



SE

Silver

Specifications

Door type	Timber or metal
Door size	Maximum width 1100mm
Door thickness	Metal - 37mm minimum Timber - 44mm minimum
Door weight	Maximum 80kg
Applications	Non hold open Hold open 90° Hold open 105°
Maximum angle of opening	130°
Adjustment controls	Closing speed 90°-15° Latching speed 15°-0°
Strength	2-4 adjustable
Options	Cover plate for timber and metal frame

Bottom view



Top view

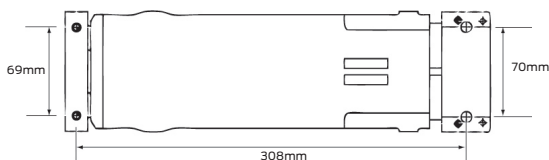

Side view

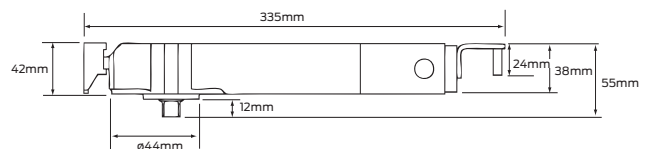

End view

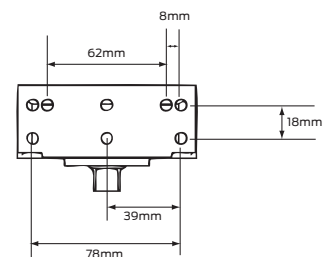

2800 Series mounting details

Side load

Double or single-action aluminium door and frame 16mm top rail

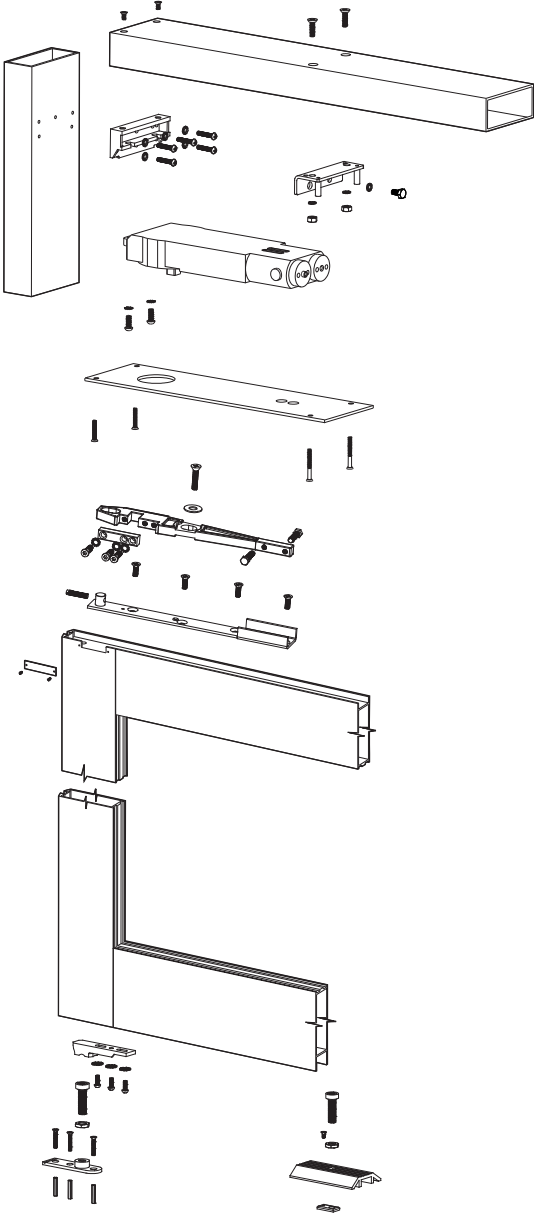

Briton 2800 Series concealed transom closers can also be fitted to timber doors and hollow metal doors

2800 Series accessories

Side load arm and DP pivot kit 2800-SLP (standard)

Side load arm to suit 16mm recessed metal top rail. Pivot has adjustable height and capacity up to 80kg door weight. Kit includes components to configure pivot to suit floor mounting or threshold mounting

Standard floor mounted pivot

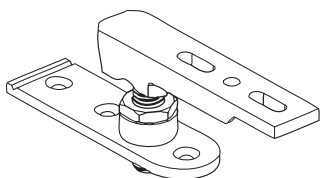

Threshold mounted pivot

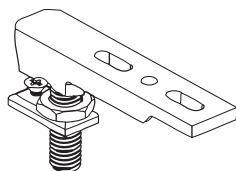

Side load arm

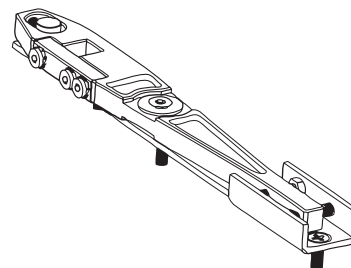

Wood cover plate 2800W-CP-SE

Aesthetic cover plate for timber applications

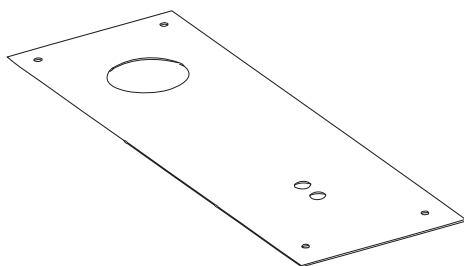

Aluminium cover plate 2800A-CP-SE

Aesthetic cover plate for aluminium applications

