

# Deadbolts



 **accesshardware** | BUSINESS REWARDS 

We take the worry out of  
protecting what's valuable to you.  
Lockwood: *no worries*<sup>®</sup>

**LOCKWOOD**

**ASSA ABLOY**

**25YEAR** MECHANICAL WARRANTY

[www.lockweb.com.au](http://www.lockweb.com.au)

# Contents



**Paradigm®**  
005 Double  
Cylinder Deadbolt  
**page 3**



**Paradigm®**  
Pull Handle Lockset  
Deadbolt  
**page 7**



**Paradigm®**  
Pull Handle Lockset  
Deadlatch  
**page 9**



**Paradigm®**  
Pull Handle Lockset  
Dummy Handle  
**page 11**



**Symmetry®**  
Deadbolt Single Cylinder  
**page 14**



**Symmetry®**  
Double Cylinder  
**page 16**

# Paradigm® 005 Double Cylinder Deadbolt



The Paradigm® 005 Double Cylinder Deadbolt is the premium security solution with its innovative safety features. The contemporary styling can be combined with any lever or entrance handle to create an elegant security solution, ideal for residential and architectural applications.

## Key Features

- Three function modes with DualSelect® provides combination of convenience and security
- High security cut resistant stainless steel bolt
- Safety Release™ automatically unlocks internal knob upon key entry from outside
- LockAlert® indicator shows lock status at a glance
- Available in round or square rose

## Restricted Special Keying

Lockwood locks can be keyed to a number of controlled and/or specially keyed systems. These range from legally protected keys to protect against unauthorised duplication, which can also include specially designed key systems such as master key systems, which allow for different levels of mechanical access control.

Please refer to Lockwood Keying Catalogue or contact your local sales office or customer service for specific information.

## Retrofitable

Replace your existing Deadbolt. Fits 54mm hole. 60-70mm adjustable backset. 32-48mm door thickness.

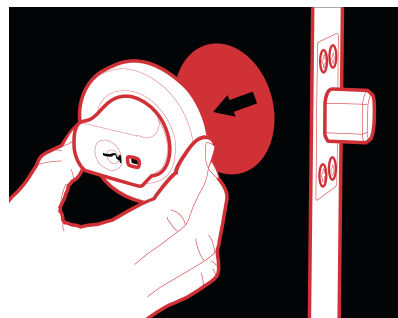

## Product Details

<b>Backset</b>	60 to 70mm adjustable stainless steel bolt
<b>Bolt</b>	High security, cut resistant stainless steel bolt
<b>Cylinder</b>	5 pin tumbler mechanism. Brass cylinder and brass barrel
<b>Door Thickness</b>	32–48mm 32–36mm doors require a spacer (Included)
<b>Finishes</b>	Chrome Plate (CP) Satin Chrome Pearl (SP) Satin Chrome Brushed (SC) Everbrass (EVB) Satin Stainless Steel (SSS)*
<b>Keying</b>	Supplied individually keyed with two keys per lock, 78,000 key combinations, Key blank KB2015P
<b>Materials</b>	High purity zinc alloy. Stainless steel version features 304 grade satin stainless steel rose, turn knob and trim
<b>Strike</b>	Box strike with concealed crossgrain door frame strengthening screw

\*Satin Stainless Steel version only available in round rose.

## Standards and Compliance

<b>SL8</b>	(Security) Australian Lock Standard (AS4145.2 - 2008)
<b>D8</b>	(Durability) Australian Lock Standard (AS4145.2 - 2008)
<b>C6</b>	(Corrosion) Australian Lock Standard AS4145.2 - 2008)
<b>K5</b>	(Key Security) Australian Lock Standard AS4145.2 - 2008)

# Paradigm® 005 Double Cylinder Deadbolt

## Round Rose



Exterior



Interior

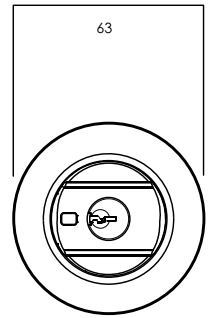
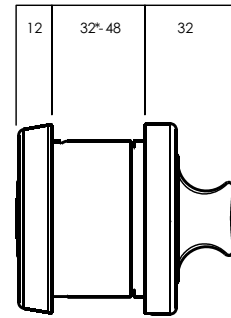
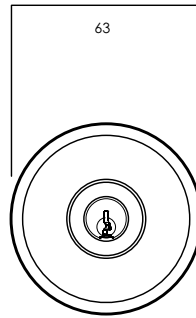

\*32–36mm door thickness requires spacer ring (included)



**Kinetic Defence®**  
Bump and pick resistant.



**Counterbalance Bolt**  
Proportionally distributes the load between the door and door frame.



**DualSelect®**  
Turn the key for safety mode. Turn the key further to select secure mode.



**2 Keys Included**  
Can be keyed alike to other Lockwood door locks.



**SafetyRelease™**  
Minimises the risk of being locked in.



**Retrofitable**  
Replace your existing Deadbolt. Fits 54mm hole. 60-70mm adjustable backset. 32-48mm door thickness.



**Anti-Corrosion**  
Successfully tested in accordance with AS2332.3.1:2001 neutral salt spray test.



**LockAlert®**  
Interior Indicator shows lock status at a glance.



**Safety Mode**  
Securely locked from outside and free from inside.



**Secure Mode**  
Securely locked from both inside and outside. For when nobody is home.



**Passage Mode**  
Free to enter from outside and free to exit from inside.

# Paradigm® 005 Double Cylinder Deadbolt

## Square Rose



Exterior



Interior

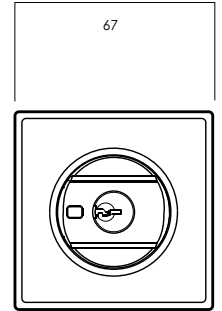
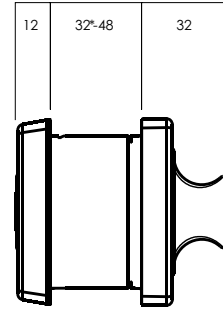
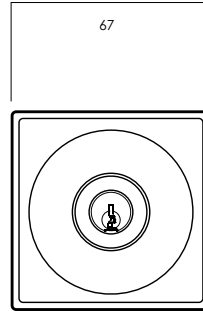

\*32–36mm door thickness requires spacer ring (included)



**Kinetic Defence®**  
Bump and pick resistant.



**Counterbalance Bolt**  
Proportionally distributes the load between the door and door frame.



**DualSelect®**  
Turn the key for safety mode. Turn the key further to select secure mode.



**2 Keys Included**  
Can be keyed alike to other Lockwood door locks.



**SafetyRelease™**  
Minimises the risk of being locked in.



**Retrofitable**  
Replace your existing Deadbolt. Fits 54mm hole. 60-70mm adjustable backset. 32-48mm door thickness.



**Anti-Corrosion**  
Successfully tested in accordance with AS2332.3.1:2001 neutral salt spray test.



**LockAlert®**  
Interior Indicator shows lock status at a glance.



**Safety Mode**  
Securely locked from outside and free from inside.



**Secure Mode**  
Securely locked from both inside and outside. For when nobody is home.



**Passage Mode**  
Free to enter from outside and free to exit from inside.

# Paradigm® 005 Double Cylinder Deadbolt

## Ordering Procedure—Lever Sets

Sample part number 005/B1CPDP is made up of several sections. Choose your product by selecting an option from each section.

## Paradigm® 005 Double Cylinder Deadbolt

Series	Type	Rose Style	Finish	Packaging	Keying
005	B	1	CP	DP	

Series	Rose Style	Packaging
Paradigm® Deadbolt 005	Round 1	Universal Pack DP
	Square 2	Trade Pack

Type	Finish	Keying Options
Bolt B	Satin Chrome Pearl SP	Special Keying-Residential Keyed Alike 5P 5KA
	Satin Chrome Brushed LSC	Keyed Alike 6P 6KA
	Chrome Plate CP	Project Keyed 5P 5PK
	Everbrass EVB*	Project Keyed 6P 6PK
	Satin Stainless Steel SSS*	Restricted Profile 5P 5RP

\* Only available in Round Rose.

\* For keying options please contact customer service.

# Paradigm® Pull Handle Lockset - Deadbolt



The Australian designed Paradigm® Pull Handle Lockset expresses superior state-of-the-art design featuring a contemporary style that delivers exceptional safety and security.

Suitable for residential, new building and renovation market applications.

The Pull Handle lockset incorporates innovative safety features from the Paradigm 005 Deadbolt and is manufactured with high end 304 grade stainless steel that comes in a brushed satin finish.

## Key Features

- Three function modes with DualSelect® provides combination of convenience and security
- High security cut resistant stainless steel bolt
- Brushed 304 Grade Stainless Steel Pull Handles
- Concealed screw fixings gives a neat and clean appearance
- Safety Release™ automatically unlocks internal knob upon key entry from outside
- LockAlert® indicator shows lock status at a glance

## Restricted Special Keying

Lockwood locks can be keyed to a number of controlled and/or specially keyed systems. These range from legally protected keys to protect against unauthorised duplication, which can also include specially designed key systems such as master key systems, which allow for different levels of mechanical access control.

Please refer to Lockwood Keying Catalogue or contact your local sales office or customer service for specific information.

## Product Details

<b>Dimensions</b>	External handle length - 600mm Internal handle length - 500mm Handle width - 30mm
<b>Backset</b>	60mm-70mm adjustable
<b>Bolt</b>	High security cut resistant
<b>Cylinder</b>	5 pin tumbler mechanism Brass cylinder and brass barrel
<b>Door Thickness</b>	32 - 48mm 32-36mm doors require a spacer (Included)
<b>Finishes</b>	Satin Stainless Steel (SSS)
<b>Materials</b>	304 Grade Stainless Steel
<b>Strike</b>	Box strike with concealed crossgrain door frame strengthening screw
<b>Magnets</b>	Door Magnets included to hold the door(s) in position when in passage mode (free to enter from outside and free to exit from inside)
<b>Keying</b>	<ul style="list-style-type: none"> <li>• Supplied individually keyed with two keys per lock</li> <li>• 78,000 key combinations</li> <li>• Key blank KB2015P</li> </ul>

## Standards and Compliance

<b>SL8</b>	(Security) Australian Lock Standard (AS4145.2 - 2008)
<b>D8</b>	(Durability) Australian Lock Standard (AS4145.2 - 2008)
<b>C6</b>	(Corrosion) Australian Lock Standard AS4145.2 - 2008)
<b>K5</b>	(Key Security) Australian Lock Standard AS4145.2 - 2008)

# Paradigm® Pull Handle Lockset - Deadbolt



Exterior

Interior

## Pull Handle Lockset

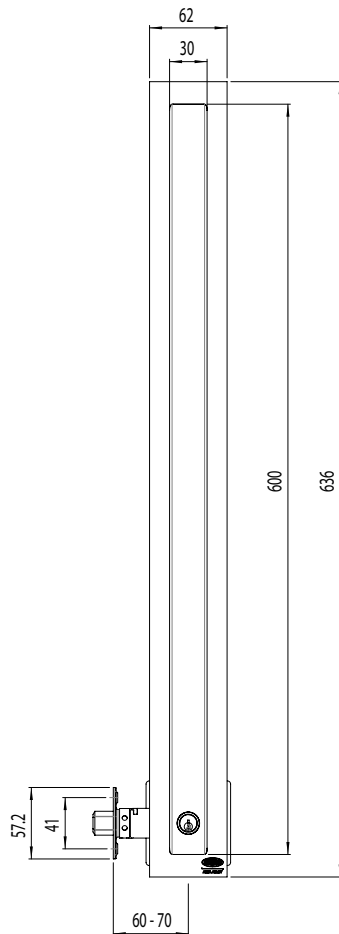

Exterior View

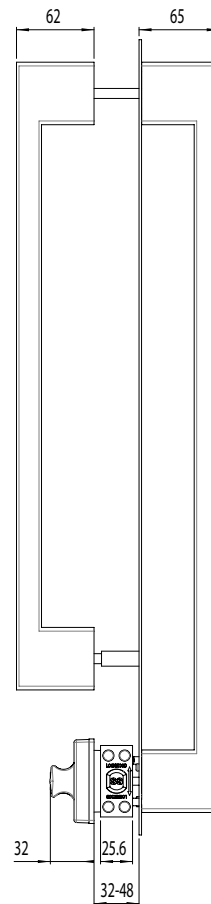

Door Thickness

Side View

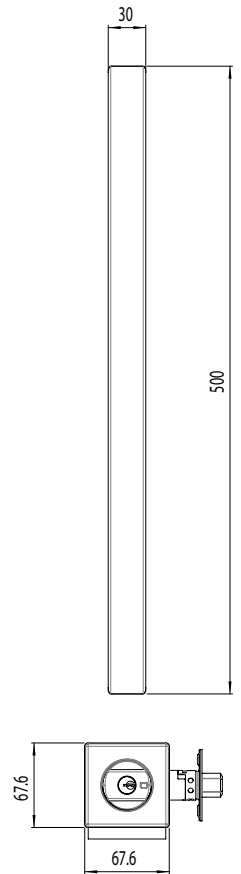

Interior View



**DualSelect®**  
Turn the key for safety mode. Turn the key further to select secure mode.



**SafetyRelease™**  
Minimises the risk of being locked in.



**Corrosion Resistant**  
Successfully tested in accordance with AS2332.3.1:2001 neutral salt spray test.



**Kinetic Defence®**  
Bump and pick resistant.



**Counterbalance Bolt**  
Proportionally distributes the load between the door and door frame.



**2 Keys Included**  
Can be keyed alike to other Lockwood door locks.



**Door Thickness**  
32mm to 48mm.



**LockAlert®**  
Interior Indicator shows lock status at a glance.



**Safety Mode**  
Securely locked from outside and free from inside.



**Secure Mode**  
Securely locked from both inside and outside. For when nobody is home.



**Passage Mode**  
Free to enter from outside and free to exit from inside.



# Paradigm® Pull Handle Lockset - Deadlatch



Interior View - Single Cylinder Shown



The Australian designed Paradigm® Pull Handle Lockset expresses superior state-of-the art design featuring a contemporary style that delivers exceptional safety and security. The Paradigm® Pull Handle latching lockset is available in single and double cylinder variants.

Both variants are specifically designed for semi-commercial and apartment building applications. The locksets have been successfully tested up to 2 hours (depending on the type of doorset) on fire assemblies in accordance with Australian Standard AS1905.1-2005, part 1: Fire Resistant Doorset.

The Pull Handle lockset applies the innovative safety features from the Paradigm 005 Deadbolt into a latching lockset and is manufactured with high end 304 grade stainless steel that comes in a brushed satin finish.

## Key Features

- High security cut resistant Stainless Steel latch
- Brushed 304 grade Stainless Steel Pull Handle
- Concealed screw fixings for a neat and clean appearance
- Safety Release™ automatically unlocks internal knob upon key entry from outside\*
- LockAlert® indicator shows lock status at a glance\*

\*Only available in double cylinder variant

## Restricted Special Keying

Lockwood locks can be keyed to a number of controlled and/or specially keyed systems. These range from legally protected keys to protect against unauthorised duplication, which can also include specially designed key systems such as master key systems, which allow for different levels of mechanical access control.

Please refer to Lockwood Keying Catalogue or contact your local sales office or customer service for specific information.

## Product Details

<b>Dimensions</b>	External handle length - 600mm Internal handle length - 500mm Handle width - 30mm
<b>Backset</b>	60mm
<b>Latch</b>	High security cut resistant Stainless Steel deadlatch
<b>Cylinder</b>	5 pin tumbler mechanism Brass cylinder and brass barrel
<b>Door Thickness</b>	32-48mm 32-36mm require a spacer (included)
<b>Finishes</b>	Satin Stainless Steel (SSS)
<b>Materials</b>	304 Grade Stainless Steel
<b>Keying</b>	<ul style="list-style-type: none"> <li>• Supplied individually keyed with two keys per lock</li> <li>• 78,000 key combinations</li> <li>• Key blank KB2015P</li> </ul>

## Standards and Compliance



The Paradigm Pull Handle latching Lockset has been successfully tested up to 2 hours (depending on the type of doorset) on fire assemblies in accordance with Australian Standard AS1905.1-2005, part 1: Fire Resistant Doorset for commercial applications.

<b>SL7</b>	(Security) Australian Lock Standard (AS4145.2 - 2008)
<b>D8</b>	(Durability) Australian Lock Standard (AS4145.2 - 2008)
<b>C6</b>	(Corrosion) Australian Lock Standard AS4145.2 - 2008)
<b>K5</b>	(Key Security) Australian Lock Standard AS4145.2 - 2008)

# Paradigm® Pull Handle Lockset - Deadlatch



Exterior Interior Double Cylinder Interior Single Cylinder

## Pull Handle Lockset

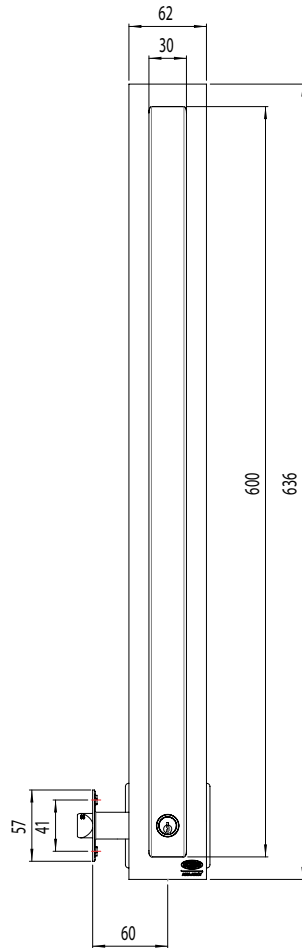

Exterior View

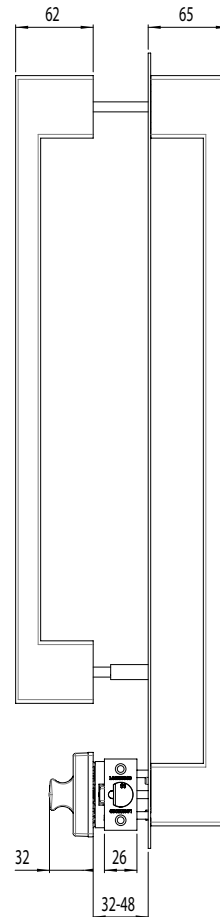

Door Thickness

Side View

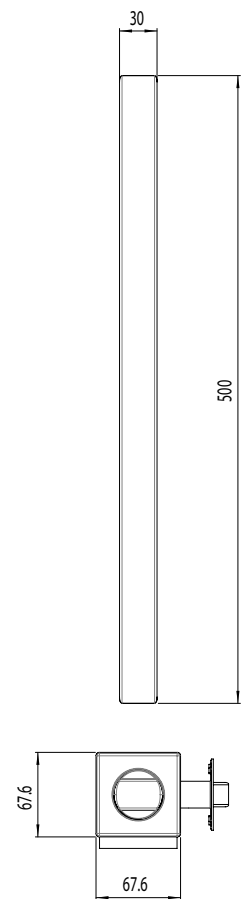

Interior View (Single Cylinder)



**SafetyRelease™\***  
Minimises the risk of being locked in.



**Door Thickness**  
32mm to 48mm.



**LockAlert™\***  
Interior Indicator shows lock status at a glance.



**Kinetic Defence®**  
Bump and pick resistant.



**2 Keys Included**  
Can be keyed alike to other Lockwood door locks.



**Safety Mode**  
Securely locked from outside and free from inside.



**Corrosion Resistant**  
Successfully tested in accordance with AS2332.3.1:2001 neutral salt spray test.



**Secure Mode\***  
Securely locked from both inside and outside. For when nobody is home.

\* Not available for Single Cylinder variant

# Paradigm® Pull Handle Lockset - Dummy Handle



Interior View - Double Cylinder Lockset  
with Dummy Handle Shown

The Australian designed Paradigm® Pull Handle Lockset expresses superior state-of-the-art design featuring a contemporary style that delivers exceptional safety and security. The Paradigm® Dummy Handle is designed to be used alongside the Paradigm Pull Handle lockset in double door applications.

Manufactured with high end 304 grade Stainless Steel that comes in a brushed satin finish, the Paradigm Dummy Handle provides premium quality with contemporary styling for modern double door entrances.

## Key Features

- Brushed 304 grade Stainless Steel Pull Handle
- Concealed screw fixings for a neat and clean appearance

## Product Details

<b>Dimensions</b>	External handle length - 600mm Internal handle length - 500mm Handle width - 30mm
<b>Door Thickness</b>	32-48mm
<b>Finishes</b>	Satin Stainless Steel (SSS)
<b>Materials</b>	304 Grade Stainless Steel

# Paradigm® Pull Handle Lockset - Dummy Handle



Exterior

Interior

## Dummy Handle

(Non-functioning) for double door application.

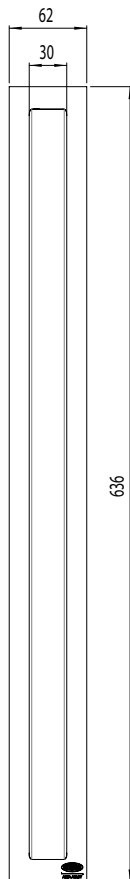

Exterior View

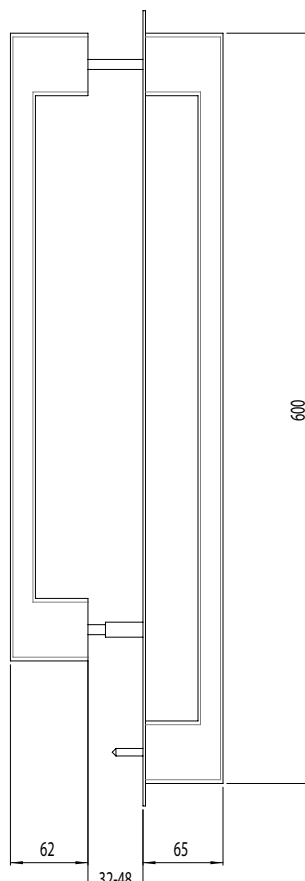

Door Thickness

Side View

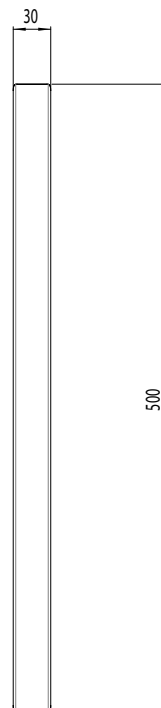

Interior View



### Corrosion Resistant

Successfully tested in accordance with AS2332.3.1:2001 neutral salt spray test.



### Door Thickness

32mm to 48mm.

# Paradigm® Pull Handle Locksets

## Ordering Procedure

Sample part number 005/DPHBSSS5PK is made up of several sections. Choose your product by selecting an option from each section.

## Paradigm® Pull Handle Locksets

Series	Type	Finish	Keying
005	DPHL	SSS	5PK

Series	Type	Finish	Keying Options																						
Paradigm® Pull Handle 005	<table border="1"> <tr> <td>Double Cylinder Deadbolt</td> <td>DPHB</td> </tr> <tr> <td>Double Cylinder Deadlatch</td> <td>DPHL</td> </tr> <tr> <td>Single Cylinder Deadlatch</td> <td>SPHL</td> </tr> <tr> <td>Dummy Handle</td> <td>PHD</td> </tr> </table>	Double Cylinder Deadbolt	DPHB	Double Cylinder Deadlatch	DPHL	Single Cylinder Deadlatch	SPHL	Dummy Handle	PHD	<table border="1"> <tr> <td>Satin Stainless Steel</td> <td>SSS</td> </tr> </table>	Satin Stainless Steel	SSS	<table border="1"> <tr> <td colspan="2">Keyed to Differ (Standard)</td> </tr> <tr> <td>Special Keying-Residential Keyed Alike 5P</td> <td>5KA</td> </tr> <tr> <td>Keyed Alike 6P</td> <td>6KA</td> </tr> <tr> <td>Project Keyed 5P</td> <td>5PK</td> </tr> <tr> <td>Project Keyed 6P</td> <td>6PK</td> </tr> <tr> <td>Restricted Profile 5P</td> <td>5RP</td> </tr> </table>	Keyed to Differ (Standard)		Special Keying-Residential Keyed Alike 5P	5KA	Keyed Alike 6P	6KA	Project Keyed 5P	5PK	Project Keyed 6P	6PK	Restricted Profile 5P	5RP
Double Cylinder Deadbolt	DPHB																								
Double Cylinder Deadlatch	DPHL																								
Single Cylinder Deadlatch	SPHL																								
Dummy Handle	PHD																								
Satin Stainless Steel	SSS																								
Keyed to Differ (Standard)																									
Special Keying-Residential Keyed Alike 5P	5KA																								
Keyed Alike 6P	6KA																								
Project Keyed 5P	5PK																								
Project Keyed 6P	6PK																								
Restricted Profile 5P	5RP																								

# Symmetry® Deadbolt



## Description

The Symmetry general purpose Deadbolts are standard security products that should be fitted with a Key in Knob or Key in Lever lockset for added safety and security.

## Keying

- Supplied individually keyed with two keys per lock
- 78,000 key combinations
- Key blank KB2015P

## Restricted Special Keying

Lockwood locks can be keyed to a number of controlled and/or specially keyed systems. These range from legally protected keys to protect against unauthorised duplication, which can also include specially designed key systems such as master key systems, which allow for different levels of mechanical access control.

Please refer to Lockwood Keying Catalogue or contact your local sales office or customer service for specific information.

## Bolt Dimensions

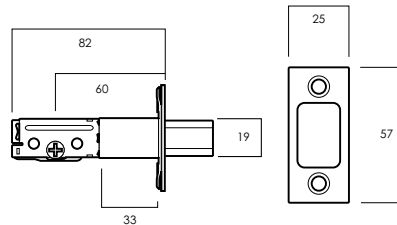

## Retrofitable

Replace your existing Deadbolt. Fits 54mm hole. 60-70mm adjustable backset. 31-45mm door thickness.

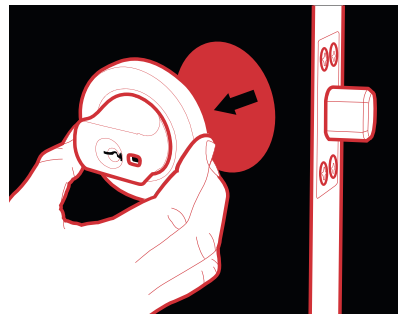

## Product Details

<b>Backset</b>	60mm to 70mm adjustable bolt
<b>Bolt</b>	Solid brass bolt with 25mm projection. Hardened insert in locking bolt
<b>Cylinder</b>	The one cylinder assembly solution "OneCyl®" has been designed for the Lockwood Symmetry Range, which grants the convenience of cylinder interchangeability. C4 brass cylinder assembly (6 pin compatible)

## Symmetry Everbrass® Guarantee



Lockwood Everbrass® product is coated both on the exterior and interior surfaces with a lifetime anti-tarnish finish. Lockwood warrants that Everbrass® branded product will not corrode, tarnish or discolour for a lifetime when properly installed and subject to no more than fair wear and tear.

## Symmetry 5 Year Finish Guarantee



Lockwood guarantees to replace Symmetry product if within five years from the proven date of purchase it tarnishes, discolours or corrodes when properly installed and subject to no more than fair wear and tear.

# Symmetry® Deadbolt

## Single Cylinder



Exterior



Interior

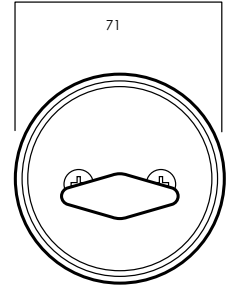
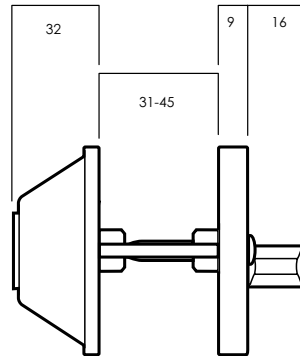
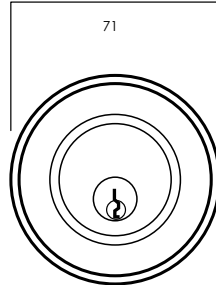

**Kinetic Defence®**  
Bump and pick resistant.



**2 Keys Included**  
Can be keyed alike to other  
Lockwood door locks.



**Retrofitable**  
Replace your existing Deadbolt. Fits  
54mm hole. 60-70mm adjustable  
backset. 31-45 door thickness.

### ONECYL® Cylinder Solution

Finish	Trade Pack	Display Pack
Polished Brass	7106PB	7106PBDP
Polished Stainless Steel	7106PSS	—
Satin Stainless Steel	7106SSS	7106SSSDP
Satin Chrome Brushed	7106SC	—

### Product Details

<b>Door Thickness</b>	31mm to 45mm 31 to 41mm requires spacer ring (included)
<b>Finishes</b>	Polished Brass ( <b>PB</b> ) Polished Stainless Steel ( <b>PSS</b> ) Satin Stainless Steel ( <b>SSS</b> ) Satin Chrome Brushed ( <b>SC</b> )
<b>Handing</b>	Suits left or right hand opening doors
<b>Keying</b>	Operated by key from outside and turn knob inside

# Symmetry® Deadbolt

## Double Cylinder



Exterior



Interior

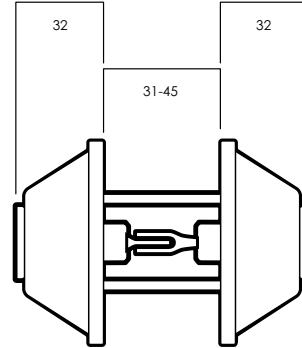
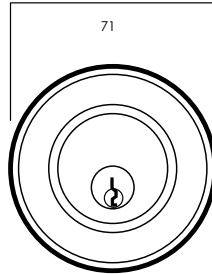

**Kinetic Defence®**  
Bump and pick resistant.



**2 Keys Included**  
Can be keyed alike to other  
Lockwood door locks.



**Retrofitable**  
Replace your existing Deadbolt. Fits  
54mm hole. 60-70mm adjustable  
backset. 31-45mm door thickness.

### ONECYL® Cylinder Solution

Finish	Trade Pack	Display Pack
EverBrass	7107EVB	7107EVBDP
Polished Stainless Steel	7107PSS	7107PSSDP
Satin Stainless Steel	7107SSS	7107SSSDP

### Product Details

<b>Door Thickness</b>	31mm to 45mm *31 to 41mm requires spacer ring (included)
<b>Finishes</b>	EverBrass ( <b>EVB</b> ) Polished Stainless Steel ( <b>PSS</b> ) Satin Stainless Steel ( <b>SSS</b> )
<b>Handing</b>	Suits left or right hand opening doors
<b>Keying</b>	Operated by key from both inside and outside



# Symmetry® Deadbolt - Accessory

## Adjustable 60-70mm Backset Bolt

**Part Number** 7541ASSS

**Finish** Satin Stainless Steel

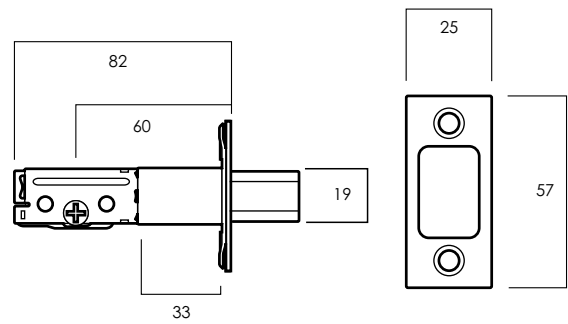



**ASSA ABLOY**

**Lockwood** is the leading brand in the Australian locking industry. With an established reputation for high quality products, this iconic brand provides a wide range of locking solutions to residential housing, commercial, semi-commercial, building and industrial application markets. Lockwood is supported by an extensive distribution and after-sales support network. Our customers include retailers, architects, trade and industrial personnel, locksmiths and security dealers.

**ASSA ABLOY** is the global leader in door opening solutions, dedicated to satisfying end-user needs for security, safety and convenience.

**ASSA ABLOY** is represented in all major regions, in both mature and emerging markets, with leading positions in Australia, Europe and North America.

**25YEAR  
MECHANICAL  
WARRANTY**

### The Lockwood 25 Year Mechanical Warranty

Our belief that we manufacture the finest premium products available in today's market place is backed by the Lockwood 25 Year Mechanical Warranty, ensuring that Lockwood continues to keep Australians safe by delivering security and peace of mind.

For warranty terms and conditions, please visit [www.lockweb.com.au](http://www.lockweb.com.au) or call **1300WARRANTY**

**ASSA ABLOY Australia Pty Ltd**  
235 Huntingdale Road  
Oakleigh, Victoria, 3166  
Australia

**1300 LOCK UP (1300 562 587)**  
[lockweb.com.au](http://lockweb.com.au)

**ASSA ABLOY New Zealand Ltd**  
6 Armstrong Road  
Albany, Auckland, 0632  
New Zealand

[info.nz@assaabloy.com](mailto:info.nz@assaabloy.com)  
Telephone +64 9415 7111  
[assaabloy.co.nz](http://assaabloy.co.nz)



*Purchase Lockwood products through Access Hardware to earn 1 Qantas Point per \$1 spent for your business\*. Find out more by calling Access Hardware customer service on 1800 555 600 or visit [accesshardware.com.au](http://accesshardware.com.au)*

\*A business must be a Qantas Business Rewards member to earn Qantas points for business. Membership and Qantas Points are subject to Qantas Business Rewards Terms and Conditions at [qantasbusinessrewards.com/terms](http://qantasbusinessrewards.com/terms) and Access Hardware Terms and Conditions at [www.accesshardware.com.au/qbr](http://www.accesshardware.com.au/qbr)

Customer Service  
**1800 555 600**

Locksmithing  
**1800 555 700**

#### Disclaimer

Whilst every effort has been made to ensure that the information (including product images and drawings) contained in this brochure is accurate at the time of publication, ASSA ABLOY Australia Pty Limited ("ASSA ABLOY") recommends that you consult ASSA ABLOY or its agents prior to placing an order to ascertain current information on specific products, as ASSA ABLOY reserves the right to make changes without notice. ASSA ABLOY will not be liable for any injury, loss or damage whatsoever, arising from any errors or omissions in the information contained in the brochure or arising from the use or application of the information contained herein. © 2017 copyright by ASSA ABLOY All rights reserved

