

# Toilet Partition Fittings



We take the worry out of  
protecting what's valuable to you.  
Lockwood: *no worries*<sup>®</sup>

**LOCKWOOD**

**ASSA ABLOY**

**25YEAR**

**MECHANICAL  
WARRANTY**

[www.lockweb.com.au](http://www.lockweb.com.au)

# Contents



## Toilet Partition Fittings

Surface-Mounted Toilet Bolts

page 3



## Toilet Partition Fittings

800 Series Surface-Mounted Toilet Bolts

page 5



## Toilet Partition Fittings

810 Series Mortice Mounted Toilet Bolt

page 7

# Surface-Mounted Toilet Bolts



## Description

Easy to install, surface-mounted toilet bolts with indicator to denote whether room is occupied or vacant. Available with slotted button.

## Product Details

<b>Materials</b>	Stainless steel castings, packed with fixing screws
<b>Finishes</b>	Polished Stainless Steel (PS) Satin Stainless Steel (SS)

# Surface-Mounted Toilet Bolts

## Surface-mounted bolt and indicator

Product	Feature	Finishes	Packaging	Part Number
L550	Slotted Button	Satin Stainless	Display Pack	L550SSDP
	Slotted Button	PolishedStainless	Display Pack	L550PSDP

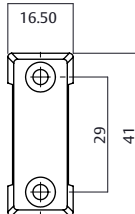
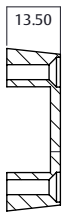
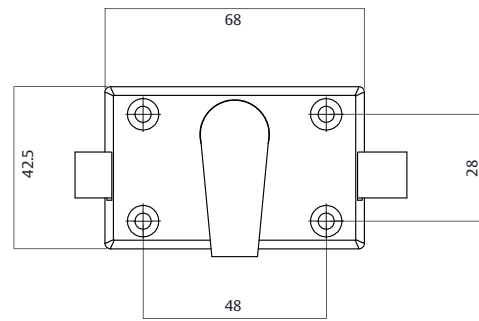
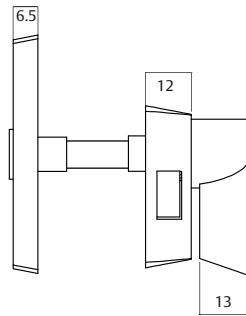
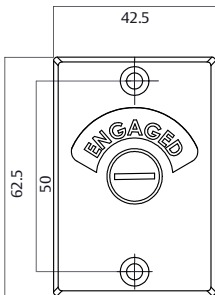

# 800 Series Surface-Mounted Toilet Bolts



## Features and Specifications

These surface-mounted bolts feature easy installation, concealed screw fixing and positive red and green indicators to denote if the room is occupied or vacant.

### Product Details

<b>Materials</b>	Brass bolt and indicator trim High purity zinc alloy case, strike rose and knob Mild steel mounting plate
<b>Door Thickness</b>	28 to 52mm
<b>Standard Finish</b>	Satin Pearl (SP)

# 800 Series Surface-Mounted Toilet Bolts

## 800 Series Surface-Mounted Toilet Bolts

Part Number	Description
801SP	Toilet bolt with indicator (emergency release)

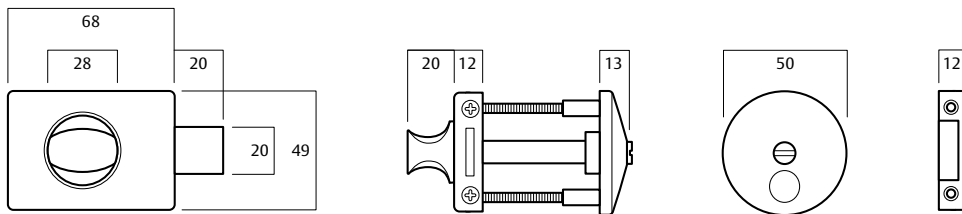

Toilet bolt with indicator  
(emergency release)

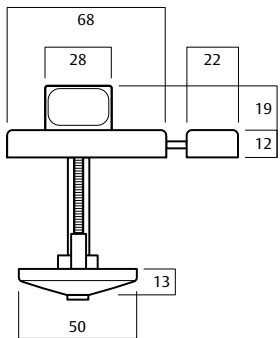

# 810 Series Mortice Mounted Toilet Bolt



## Features and Specifications

These tubular bolts feature easy installation, concealed screw fixing with positive red and green indicators to denote if the room is occupied or vacant.

### Product Details

<b>Materials</b>	Brass indicator trim Stainless steel strike High purity Zinc alloy roses, knob, bolt and case
<b>Door Thickness</b>	28 to 52mm
<b>Standard Finish</b>	Satin Pearl (SP)

# 810 Series Mortise Mounted Toilet Bolt

## 810 Series Mortise Mounted Toilet Bolt

Part Number	Description
811SP	Toilet bolt with indicator (emergency release)
812SP	Toilet bolt with indicator (hospital release)

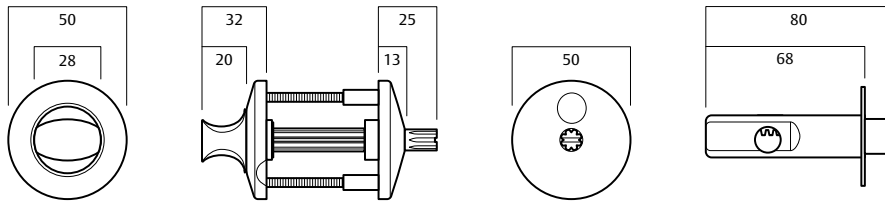

Emergency release

Hospital release

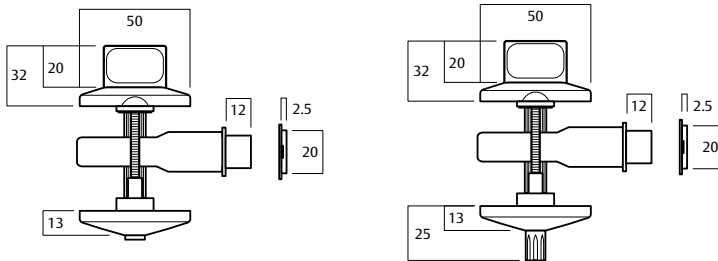





**ASSA ABLOY**

**Lockwood** is the leading brand in the Australian locking industry. With an established reputation for high quality products, this iconic brand provides a wide range of locking solutions to residential housing, commercial building and industrial application markets. Lockwood is supported by an extensive distribution and after-sales support network. Our customers include retailers, architects, trade and industrial personnel, locksmiths and security dealers.

**ASSA ABLOY** is the global leader in door opening solutions, dedicated to satisfying end-user needs for security, safety and convenience.

**ASSA ABLOY** is represented in all major regions, in both mature and emerging markets, with leading positions in Australia, Europe and North America.

**25YEAR  
MECHANICAL  
WARRANTY**

### **The Lockwood 25 Year Mechanical Warranty**

Our belief that we manufacture the finest premium products available in today's market place is backed by the Lockwood 25 Year Mechanical Warranty, ensuring that Lockwood continues to keep Australians safe by delivering security and peace of mind.

For warranty terms and conditions, please visit [www.lockweb.com.au](http://www.lockweb.com.au) or call **1300WARRANTY**

**ASSA ABLOY Australia Pty Ltd**  
235 Huntingdale Road  
Oakleigh, Victoria, 3166  
Australia

**1300 LOCK UP (1300 562 587)**  
[lockweb.com.au](http://lockweb.com.au)

**ASSA ABLOY New Zealand Ltd**  
6 Armstrong Road  
Albany, Auckland, 0632  
New Zealand

**[info.nz@assaabloy.com](mailto:info.nz@assaabloy.com)**  
**Telephone +64 9415 7111**  
**[assaabloy.co.nz](http://assaabloy.co.nz)**

