

 **ARCHITEC**<sup>®</sup>  
Australian Design

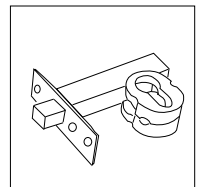

PULL HANDLE	3~25
LEVER HANDLE	26~47
NUMBERS & PLATE	48~49
HINGE	50~53
CABINET KNOB & HANDLE	54~55
LATCH & CATCH	56~57
LOCK & ACCESSORIES	58~65
FLUSH PULL & SLIDING DOOR LOCK	66~71
FLUSH BOLT	72~73
DOOR STOP & HOLDER	74~75

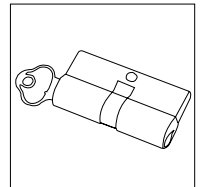

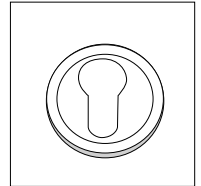
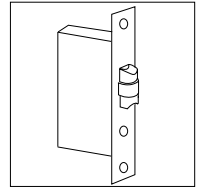
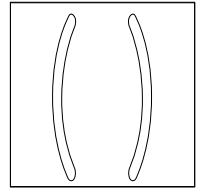
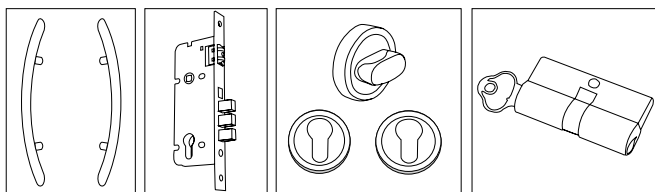
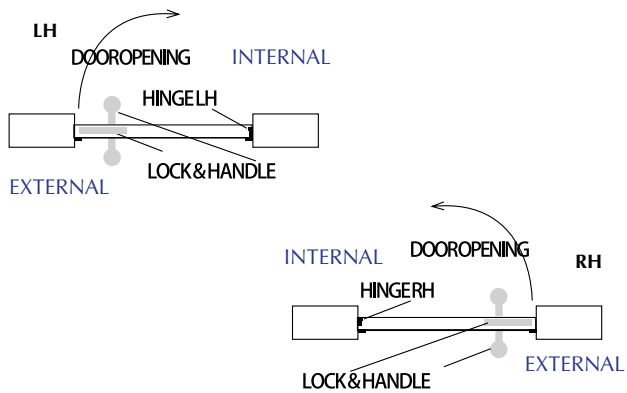

OXFORD



(a) HANDLE B2B ONLY

SIZE	PSS	BSS	BNB
450	620-10C	620-20C	620-60C
600	620-10F	620-20F	620-60F
900	620-10H	620-20H	620-60H
1200	620-10I	620-20I	
1800	620-10K	620-20K	

(b) PASSAGE SET

SIZE	PSS	BSS	BNB
450	626-10C	626-20C	626-60C
600	626-10F	626-20F	626-60F
900	626-10H	626-20H	626-60H
1200	626-10I	626-20I	
1800	626-10K	626-20K	

(c) LOCKSET A - AUS & NZ PATENT

SIZE	PSS	BSS	BNB
450	627-10C	627-20C	627-60C
600	627-10F	627-20F	627-60F
900	627-10H	627-20H	627-60H
1200	627-10I	627-20I	
1800	627-10K	627-20K	

(d) LOCKSET B - AUS PATENT

SIZE	PSS	BSS	BNB
450	628-10C	628-20C	628-60C
600	628-10F	628-20F	628-60F
900	628-10H	628-20H	628-60H
1200	628-10I	628-20I	
1800	628-10K	628-20K	

SIZE: L/O/C-C/P

450/32/275/75
600/32/350/75
900/32/560/75
1200/38/760/82
1800/38/1300/82

HANDLE ONLY

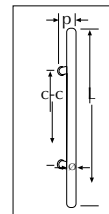

PASSAGE SET

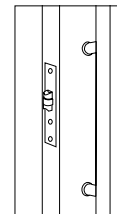

LOCKSET A

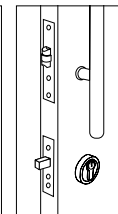

LOCKSET B

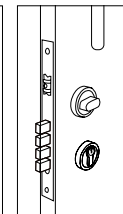

BRIGHTON



(a) HANDLE B2B ONLY

SIZE	PSS	BSS
450	620-11C	620-21C
600	620-11F	620-21F
800		620-21G
1200		620-21I

(b) PASSAGE SET

SIZE	PSS	BSS
450	626-11C	626-21C
600	626-11F	626-21F
800		626-21G
1200		626-21I

(c) LOCKSET A - AUS & NZ PATENT

SIZE	PSS	BSS
450	627-11C	627-21C
600	627-11F	627-21F
800		627-21G
1200		627-21I

(d) LOCKSET B - AUS PATENT

SIZE	PSS	BSS
450	628-11C	628-21C
600	628-11F	628-21F
800		628-21G
1200		628-21I

SIZE: L/Ø/C-C/P

HANDLE ONLY

PASSAGE SET

LOCKSET A

LOCKSET B

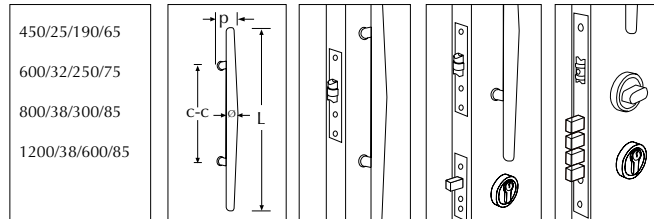

CLIFTON



(a) HANDLE B2B ONLY

SIZE	PSS	BSS
550	620-12E	620-22E
800	620-12G	620-22G

(b) PASSAGE SET

SIZE	PSS	BSS
550	626-12E	626-22E
800	626-12G	626-22G

(c) LOCKSET A - AUS & NZ PATENT

SIZE	PSS	BSS
550	627-12E	627-22E
800	627-12G	627-22G

(d) LOCKSET B - AUS PATENT

SIZE	PSS	BSS
550	628-12E	628-22E
800	628-12G	628-22G

SIZE: L/Ø/C-C/P

HANDLE ONLY

PASSAGE SET

LOCKSET A

LOCKSET B

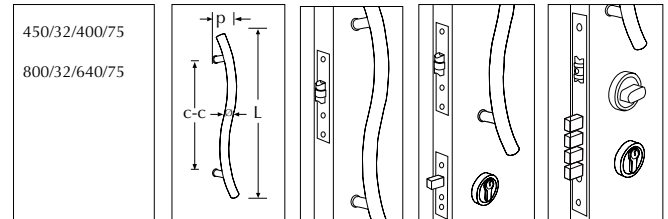

CAMBRIDGE



(a) HANDLE B2B ONLY

SIZE	PSS/BSS	BSS
600	620-44F	620-24F

(b) PASSAGE SET

SIZE	PSS/BSS	BSS
600	626-44F	626-24F

(c) LOCKSET A - AUS & NZ PATENT

SIZE	PSS/BSS	BSS
600	627-44F	627-24F

(d) LOCKSET B - AUS PATENT

SIZE	PSS/BSS	BSS
600	628-44F	628-24F

OXLEY



(a) HANDLE B2B ONLY

SIZE	BSS
600	620-25F
1200	620-25I
1800	620-25K

(b) PASSAGE SET

SIZE	BSS
600	626-25F
1200	626-25I
1800	626-25K

(c) LOCKSET A - AUS & NZ PATENT

SIZE	BSS
600	627-25F
1200	627-25I
1800	627-25K

(d) LOCKSET B - AUS PATENT

SIZE	BSS
600	628-25F
1200	628-25I
1800	628-25K

SIZE: L/O/C-C/P

600/38/300/85
---------------

HANDLE ONLY

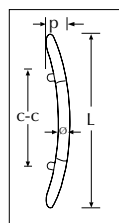

PASSAGE SET

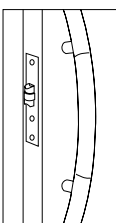

LOCKSET A

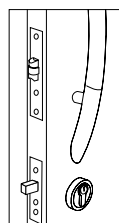

LOCKSET B

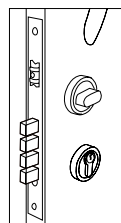

SIZE: L/O/C-C/P

600/32/400/75
1200/32/800/75
1800/38/500+900/75

HANDLE ONLY

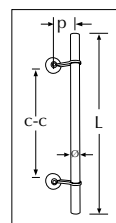

PASSAGE SET

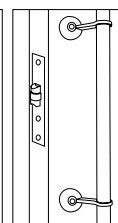

LOCKSET A

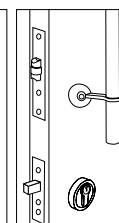

LOCKSET B

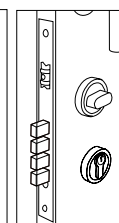

TESA



(a) HANDLE B2B ONLY

SIZE	PSS/BSS
600	620-46F
900	620-46H

(b) PASSAGE SET

SIZE	PSS/BSS
600	626-46F
900	626-46H

(c) LOCKSET A - AUS & NZ PATENT

SIZE	PSS/BSS
600	627-46F
900	627-46H

(d) LOCKSET B - AUS PATENT

SIZE	PSS/BSS
600	628-46F
900	628-46H

VITA

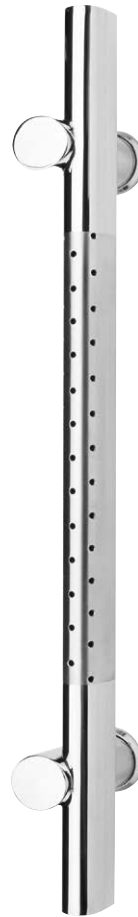

(a) HANDLE B2B ONLY

SIZE	PSS/BSS
500	620-47D
800	620-47G

(b) PASSAGE SET

SIZE	PSS/BSS
500	626-47D
800	626-47G

(c) LOCKSET A - AUS & NZ PATENT

SIZE	PSS/BSS
500	627-47D
800	627-47G

(d) LOCKSET B - AUS PATENT

SIZE	PSS/BSS
500	628-47D
800	628-47G

SIZE: L/Ø/C-C/P

600/38/530/65  
900/51/795/78

HANDLE ONLY

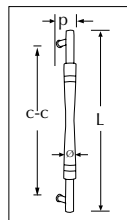

PASSAGE SET

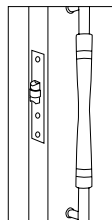

LOCKSET A

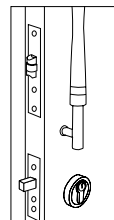

LOCKSET B

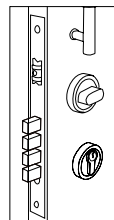

SIZE: L/Ø/C-C/P

500/19x38/350/88  
800/25x45/600/95

HANDLE ONLY

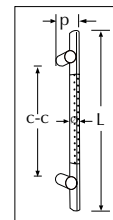

PASSAGE SET

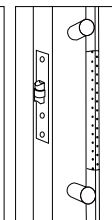

LOCKSET A

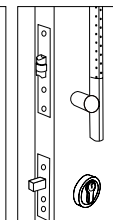

LOCKSET B

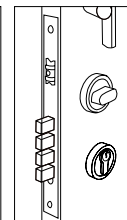

DEVA

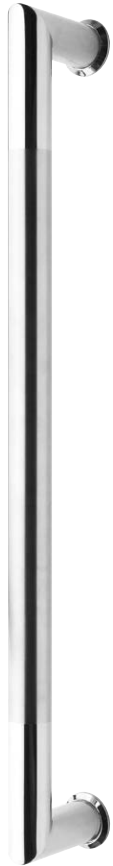

(a) HANDLE B2B ONLY

SIZE	PSS	PSS/BSS	BSS
450	620-18C	620-48C	620-28C
600	620-18F	620-48F	620-28F

(b) PASSAGE SET

SIZE	PSS	PSS/BSS	BSS
450	626-18C	626-48C	626-28C
600	626-18F	626-48F	626-28F

(c) LOCKSET A - AUS & NZ PATENT

SIZE	PSS	PSS/BSS	BSS
450	627-18C	627-48C	627-28C
600	627-18F	627-48F	627-28F

(d) LOCKSET B - AUS PATENT

SIZE	PSS	PSS/BSS	BSS
450	628-18C	628-48C	628-28C
600	628-18F	628-48F	628-28F

ROUNDINI



(a) HANDLE B2B ONLY

SIZE	PSS	BSS
450	620-190C	620-290C
600	620-190F	620-290F
900	620-190H	620-290H

(b) PASSAGE SET

SIZE	PSS	BSS
450	626-190C	626-290C
600	626-190F	626-290F
900	626-190H	626-290H

(c) LOCKSET A - AUS & NZ PATENT

SIZE	PSS	BSS
450	627-190C	627-290C
600	627-190F	627-290F
900	627-190H	627-290H

(d) LOCKSET B - AUS PATENT

SIZE	PSS	BSS
450	628-190C	628-290C
600	628-190F	628-290F
900	628-190H	628-290H

SIZE: L/Ø/C-C/P

450/32/418/80  
600/32/568/80

HANDLE ONLY

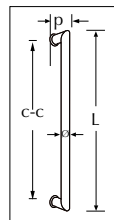

PASSAGE SET

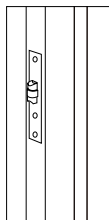

LOCKSET A

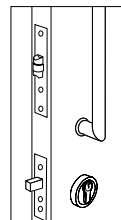

LOCKSET B

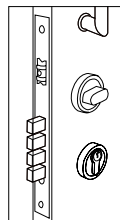

SIZE: L/Ø/C-C/P

450/25/420/72  
600/25/570/72  
900/25/870/72

HANDLE ONLY

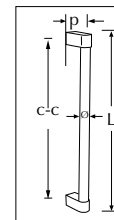

PASSAGE SET

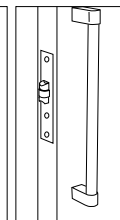

LOCKSET A

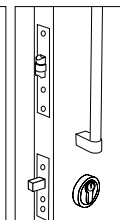

LOCKSET B

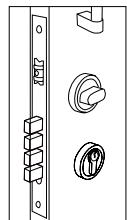

CORTINA

OFFSET C-C=33mm

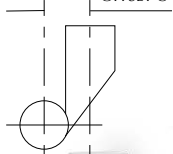

(a) HANDLE B2B ONLY

SIZE	PSS	BSS
450	620-191C	620-291C
600	620-191F	620-291F
900	620-191H	620-291H

(b) PASSAGE SET

SIZE	PSS	BSS
450	626-191C	626-291C
600	626-191F	626-291F
900	626-191H	626-291H

(c) LOCKSET A - AUS & NZ PATENT

SIZE	PSS	BSS
450	627-191C	627-291C
600	627-191F	627-291F
900	627-191H	627-291H

(d) LOCKSET B - AUS PATENT

SIZE	PSS	BSS
450	628-191C	628-291C
600	628-191F	628-291F
900	628-191H	628-291H

SIZE: L/Ø/C-C/P

HANDLE ONLY

PASSAGE SET

LOCKSET A

LOCKSET B

450/25/420/63				
600/25/570/63				
900/25/870/63				

VERONA



(a) HANDLE B2B ONLY

SIZE	PSS	BSS
450	621-10C	621-20C
600	621-10F	621-20F
900	621-10H	621-20H
1200	621-10I	621-20I
1800	621-10K	621-20K

(b) PASSAGE SET

SIZE	PSS	BSS
450	622-10C	622-20C
600	622-10F	622-20F
900	622-10H	622-20H
1200	622-10I	622-20I
1800	622-10K	622-20K

(c) LOCKSET A - AUS & NZ PATENT

SIZE	PSS	BSS
450	623-10C	623-20C
600	623-10F	623-20F
900	623-10H	623-20H
1200	623-10I	623-20I
1800	623-10K	623-20K

(d) LOCKSET B - AUS PATENT

SIZE	PSS	BSS
450	624-10C	624-20C
600	624-10F	624-20F
900	624-10H	624-20H
1200	624-10I	624-20I
1800	624-10K	624-20K

SIZE: L/Ø/C-C/P

HANDLE ONLY

PASSAGE SET

LOCKSET A

LOCKSET B

450/25x25/275/70				
600/30x30/350/75				
900/30x30/560/75				
1200/30x30/760/75				
1800/30x30/1300/75				



KENO



(a) HANDLE B2B ONLY

SIZE	PSS	BSS
450	621-11C	621-21C
600	621-11F	621-21F
1500	621-11J	621-21J

(b) PASSAGE SET

SIZE	PSS	BSS
450	622-11C	622-21C
600	622-11F	622-21F
1500	622-11J	622-21J

(c) LOCKSET A - AUS & NZ PATENT

SIZE	PSS	BSS
450	623-11C	623-21C
600	623-11F	623-21F
1500	623-11J	623-21J

(d) LOCKSET B - AUS PATENT

SIZE	PSS	BSS
450	624-11C	624-21C
600	624-11F	624-21F
1500	624-11J	624-21J

ADECO



(a) HANDLE B2B ONLY

SIZE	PSS	BSS	BNB
280	621-12A	621-22A	621-62A
380	621-12B	621-22B	621-62B
450	621-12C	621-22C	621-62C
600	621-12F	621-22F	621-62F
900	621-12H	621-22H	621-62H

(b) PASSAGE SET

SIZE	PSS	BSS	BNB
280	622-12A	622-22A	622-62A
380	622-12B	622-22B	622-62B
450	622-12C	622-22C	622-62C
600	622-12F	622-22F	622-62F
900	622-12H	622-22H	622-62H

(c) LOCKSET A - AUS & NZ PATENT

SIZE	PSS	BSS	BNB
280	623-12A	623-22A	623-62A
380	623-12B	623-22B	623-62B
450	623-12C	623-22C	623-62C
600	623-12F	623-22F	623-62F
900	623-12H	623-22H	623-62H

(d) LOCKSET B - AUS PATENT

SIZE	PSS	BSS	BNB
280	624-12A	624-22A	624-62A
380	624-12B	624-22B	624-62B
450	624-12C	624-22C	624-62C
600	624-12F	624-22F	624-62F
900	624-12H	624-22H	624-62H

SIZE: L/O/C-C/P

HANDLE ONLY

PASSAGE SET

LOCKSET A

LOCKSET B

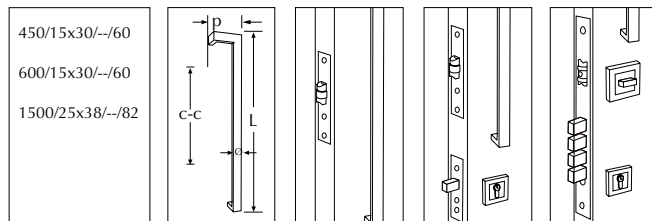

SIZE: L/O/C-C/P

HANDLE ONLY

PASSAGE SET

LOCKSET A

LOCKSET B

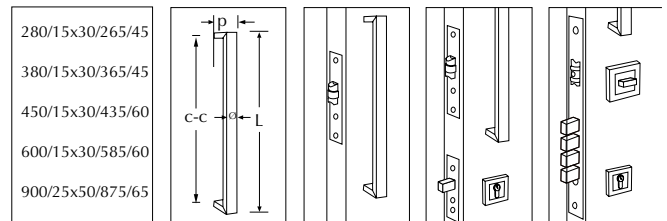

ROMA



(a) HANDLE B2B ONLY

SIZE	CP	BSC
280	621-13A	621-23A
380	621-13B	621-23B

(b) PASSAGE SET

SIZE	CP	BSC
280	622-13A	622-23A
380	622-13B	622-23B

(c) LOCKSET A - AUS & NZ PATENT

SIZE	CP	BSC
280	623-13A	623-23A
380	623-13B	623-23B

(d) LOCKSET B - AUS PATENT

SIZE	CP	BSC
280	624-13A	624-23A
380	624-13B	624-23B

SIZE: L/Ø:C/C/P

HANDLE ONLY

PASSAGE SET

LOCKSET A

LOCKSET B

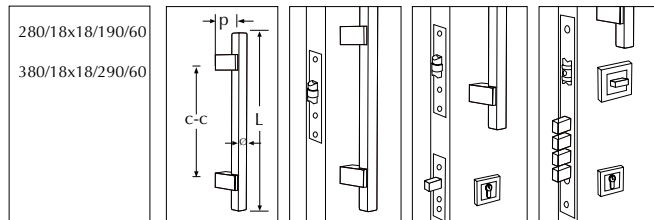

FINITY



(a) HANDLE B2B ONLY

SIZE	PSS	BSS
450	621-15C	621-25C
600	621-15F	621-25F
900	621-15H	621-25H
1200	621-15I	621-25I

(b) PASSAGE SET

SIZE	PSS	BSS
450	622-15C	622-25C
600	622-15F	622-25F
900	622-15H	622-25H
1200	622-15I	622-25I

(c) LOCKSET A - AUS & NZ PATENT

SIZE	PSS	BSS
450	623-15C	623-25C
600	623-15F	623-25F
900	623-15H	623-25H
1200	623-15I	623-25I

(d) LOCKSET B - AUS PATENT

SIZE	PSS	BSS
450	624-15C	624-25C
600	624-15F	624-25F
900	624-15H	624-25H
1200	624-15I	624-25I

SIZE: L/Ø:C/C/P

HANDLE ONLY

PASSAGE SET

LOCKSET A

LOCKSET B

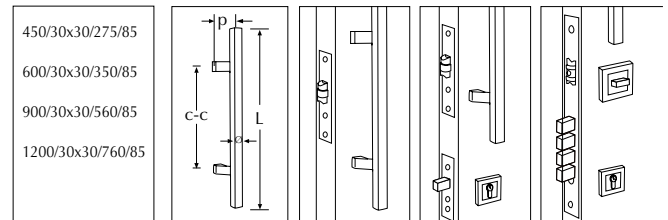

HAMPTON



(a) HANDLE B2B ONLY

SIZE	PSS	BSS
450	621-17C	621-27C
600	621-17F	621-27F
900	621-17H	621-27H

(b) PASSAGE SET

SIZE	PSS	BSS
450	622-17C	622-27C
600	622-17F	622-27F
900	622-17H	622-27H

(c) LOCKSET A - AUS & NZ PATENT

SIZE	PSS	BSS
450	623-17C	623-27C
600	623-17F	623-27F
900	623-17H	623-27H

(d) LOCKSET B - AUS PATENT

SIZE	PSS	BSS
450	624-17C	624-27C
600	624-17F	624-27F
900	624-17H	624-27H

SIZE: L/Ø/C-C/P

HANDLE ONLY

PASSAGE SET

LOCKSET A

LOCKSET B

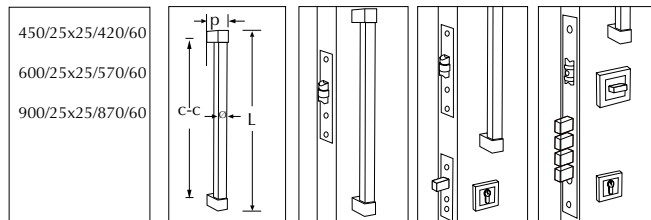

COTTO



(a) HANDLE B2B ONLY

SIZE	PSS	BSS
450	621-18C	621-28C
600	621-18F	621-28F
900	621-18H	621-28H

(b) PASSAGE SET

SIZE	PSS	BSS
450	622-18C	622-28C
600	622-18F	622-28F
900	622-18H	622-28H

(c) LOCKSET A - AUS & NZ PATENT

SIZE	PSS	BSS
450	623-18C	623-28C
600	623-18F	623-28F
900	623-18H	623-28H

(d) LOCKSET B - AUS PATENT

SIZE	PSS	BSS
450	624-18C	624-28C
600	624-18F	624-28F
900	624-18H	624-28H

SIZE: L/Ø/C-C/P

HANDLE ONLY

PASSAGE SET

LOCKSET A

LOCKSET B

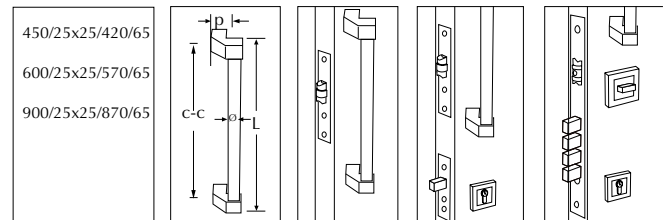

METRIC



(a) HANDLE B2B ONLY

SIZE	BSS	BNB
100	621-26S	621-66S
150	621-26M	621-66M
200	621-26L	621-66L



(b) PASSAGE SET

SIZE	BSS	BNB
100	622-26S	622-66S
150	622-26M	622-66M
200	622-26L	622-66L

(c) LOCKSET A - AUS & NZ PATENT

SIZE	BSS	BNB
100	623-26S	623-66S
150	623-26M	623-66M
200	623-26L	623-66L

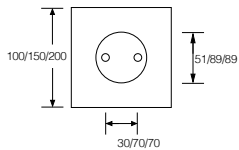

(d) LOCKSET B - AUS PATENT

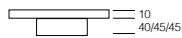

SIZE	BSS	BNB
100	624-26S	624-66S
150	624-26M	624-66M
200	624-26L	624-66L

HANDLE ONLY

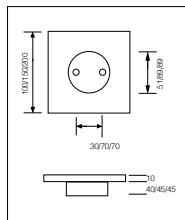

PASSAGE SET

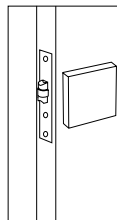

LOCKSET A

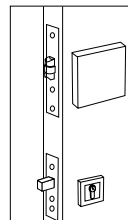

LOCKSET B

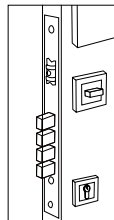

KENNY



(a) HANDLE B2B ONLY

SIZE	BSS	BNB
300	621-24	621-64



(b) PASSAGE SET

SIZE	BSS	BNB
300	622-24	622-64

(c) LOCKSET A - AUS & NZ PATENT

SIZE	BSS	BNB
300	623-24	623-64

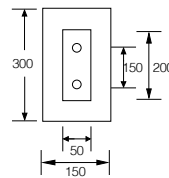

(d) LOCKSET B - AUS PATENT

SIZE	BSS	BNB
300	624-24	624-24

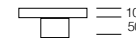

HANDLE ONLY

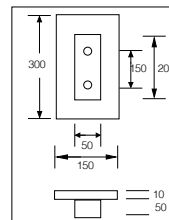

PASSAGE SET

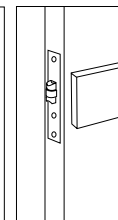

LOCKSET A

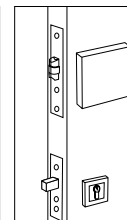

LOCKSET B

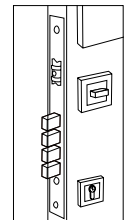

ABBY

(a) HANDLE B2B ONLY

SIZE	BSS	BNB
100	620-23S	620-63S
150	620-23M	620-63M
200	620-23L	620-63L

(b) PASSAGE SET

SIZE	BSS	BNB
100	626-23S	626-63S
150	626-23M	626-63M
200	626-23L	626-63L

(c) LOCKSET A - AUS & NZ PATENT

SIZE	BSS	BNB
100	627-23S	627-63S
150	627-23M	627-63M
200	627-23L	627-63L

(d) LOCKSET B - AUS PATENT

SIZE	BSS	BNB
100	628-23S	628-63S
150	628-23M	628-63M
200	628-23L	628-63L

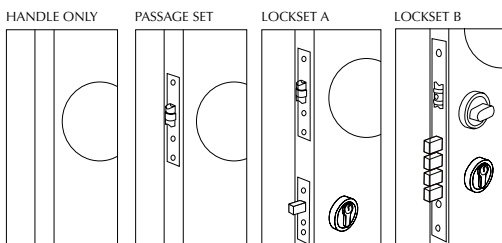
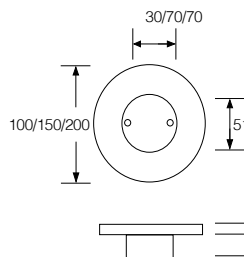

SEIKO

(a) HANDLE B2B ONLY

SIZE	BSS	BNB
150	620-29S	620-69S
200	620-29M	620-69M
300	620-29L	620-69L

(b) PASSAGE SET

SIZE	BSS	BNB
150	626-29S	626-69S
200	626-29M	626-69M
300	626-29L	626-69L

(c) LOCKSET A - AUS & NZ PATENT

SIZE	BSS	BNB
150	627-29S	627-69S
200	627-29M	627-69M
300	627-29L	627-69L

(d) LOCKSET B - AUS PATENT

SIZE	BSS	BNB
150	628-29S	628-69S
200	628-29M	628-69M
300	628-29L	628-69L

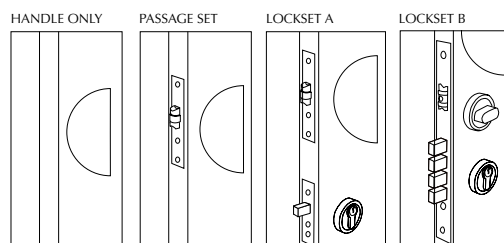
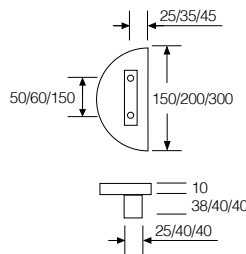

PASSAGE SET



- Suitable for passage doors, corridor doors.
- Corresponding parts: Tubular Latch.
- Options:  
To avoid the handle hit against the wall, a suitable Door Stop is required.

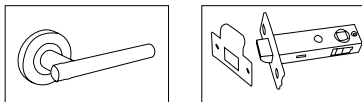

PRIVCY SET



- Suitable for bathroom doors, toilet doors and bedroom doors.
- Corresponding parts: Privacy Latch with Push Pin.
- Options:  
To avoid the handle hit against the wall, a suitable Door Stop is required.

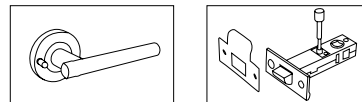

LOCK SET (A)



- Suitable for front doors.
- Corresponding parts: Tubular Latch, Dead Bolt, Euro Double Cylinder, and Escutcheons with euro key hole.
- Options:
  - a) Inside Turn Snib Cylinder.
  - b) To avoid the handle hit against the wall, a suitable Door Stop is required.

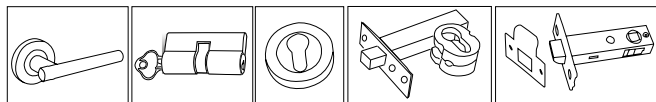

LOCK SET(B)



- Suitable for front doors.
- Corresponding parts: Mortise Latch Lock, Euro Double Cylinder.
- Options:
  - a) Inside Turn Snib Cylinder.
  - b) To avoid the handle hit against the wall, a suitable Door Stop is required.

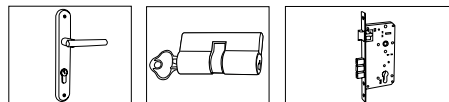

LOCK SET (C)



- Suitable for front doors.
- Corresponding parts: double action Mortise Lock with anti-file proved Dead Bolt and a Euro Double Cylinder. -Options:
- a) To avoid the handle hit against the wall, a suitable Door Stop is required.
- b) For double door situation, two Flush Bolts and a Rebate Conversion Kit may apply.
- c) For glass panel doors or metal doors, please choose suitable backset for the Mortise Lock.
- Please indicate handing for handles when ordering. (The picture shown above is LH)

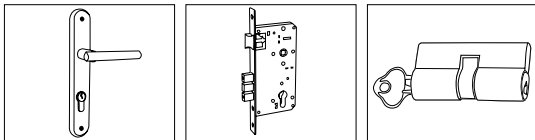

CLIFTON



(a) HANDLE B2B ONLY

CP	BSC	BNI
604-10	604-20	604-30

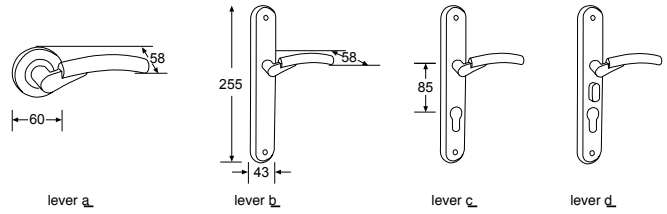

(b) PASSAGE

CP	BSC	BNI
614-10	614-20	614-30

(c) PRIVACY

CP	BSC	BNI
634-10	634-20	634-30

(d) LOCKSET A

CP	BSC	BNI
654-10	654-20	654-30

(e) LOCKSET B

CP	BSC	BNI
665-10	665-20	665-30

(f) LOCKSET C

CP	BSC	BNI
675-10	675-20	675-30

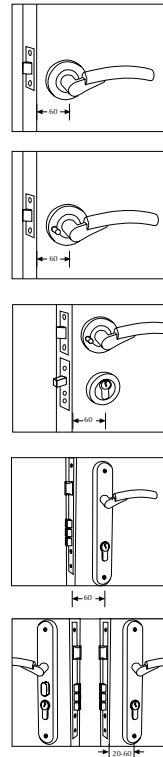



OXFORD



(a) HANDLE B2B ONLY

CP	BSC	BNI
604-12	604-22	604-32

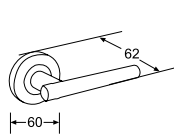

lever a

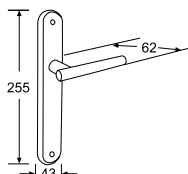

lever b

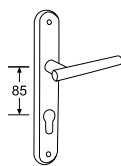

lever c

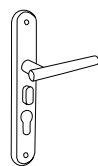

lever d

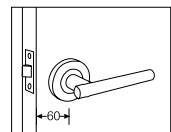

(b) PASSAGE

CP	BSC	BNI
614-12	614-22	614-32

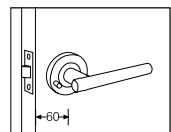

(c) PRIVACY

CP	BSC	BNI
634-12	634-22	634-32

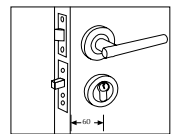

(d) LOCKSET A

CP	BSC	BNI
654-12	654-22	654-32

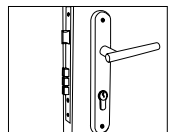

(e) LOCKSET B

CP	BSC	BNI
665-12	665-22	665-32

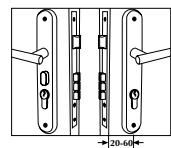

(f) LOCKSET C

CP	BSC	BNI
675-12	675-22	675-32

WINDSOR



(a) HANDLE B2B ONLY

CP	BSC	MSC/CP
604-14	604-24	604-44

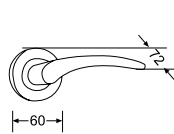

lever a

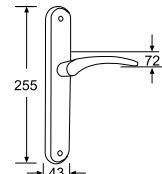

lever b

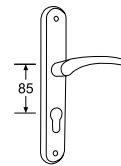

lever c

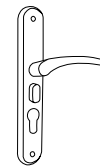

lever d

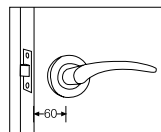

(b) PASSAGE

CP	BSC	MSC/CP
614-14	614-24	614-44

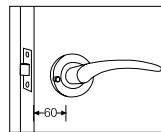

(c) PRIVACY

CP	BSC	MSC/CP
634-14	634-24	634-44

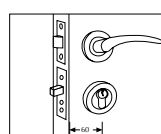

(d) LOCKSET A

CP	BSC	MSC/CP
654-14	654-24	654-44

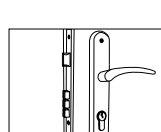

(e) LOCKSET B

CP	BSC	MSC/CP
665-14	665-24	665-44

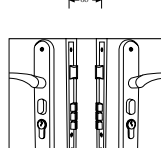

(f) LOCKSET C

CP	BSC	MSC/CP
675-14	675-24	675-44

GEORGIAN



(a) HANDLE B2B ONLY			
PB	CP	BSC	
604-05	604-15	604-25	

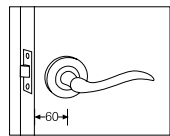
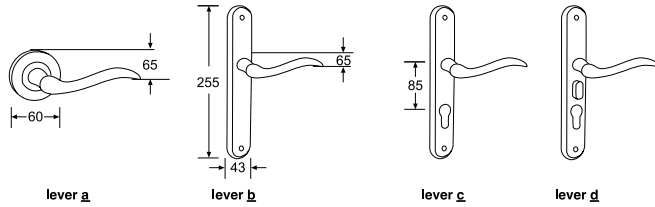

(b) PASSAGE			
PB	CP	BSC	
614-05	614-15	614-25	

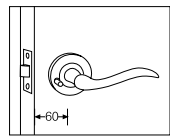

(c) PRIVACY			
PB	CP	BSC	
634-05	634-15	634-25	

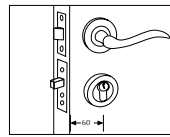

(d) LOCKSET A			
PB	CP	BSC	
654-05	654-15	654-25	

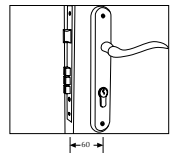

(e) LOCKSET B			
PB	CP	BSC	
665-05	665-15	665-25	

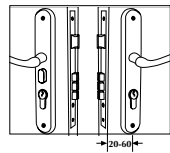

(f) LOCKSET C			
PB	CP	BSC	
675-05	675-15	675-25	

TESA



(a) HANDLE B2B ONLY		BSC
		604-26

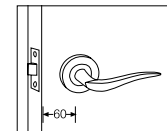
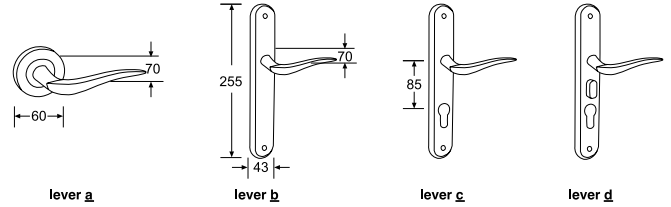

(b) PASSAGE		BSC
		614-26

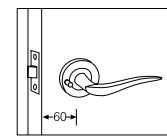

(c) PRIVACY		BSC
		634-26

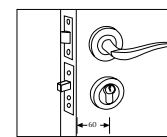

(d) LOCKSET A		BSC
		654-26

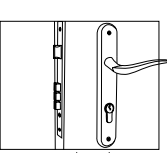

(e) LOCKSET B		BSC
		665-26

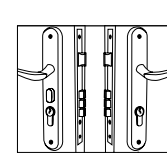

(f) LOCKSET C		BSC
		675-26

BRIGHTON



(a) HANDLE B2B ONLY

CP	BSC	MSC/CP
604-17	604-27	604-47

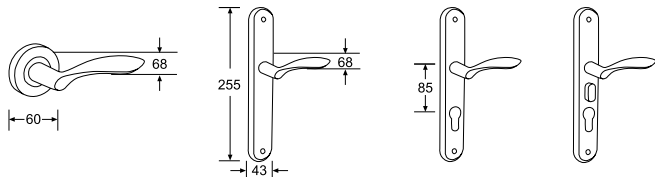

lever a

lever b

lever c

lever d

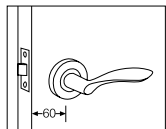

(b) PASSAGE

CP	BSC	MSC/CP
614-17	614-27	614-47

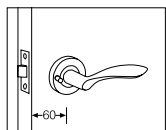

(c) PRIVACY

CP	BSC	MSC/CP
634-17	634-27	634-47

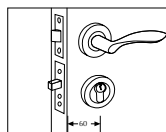

(d) LOCKSET A

CP	BSC	MSC/CP
654-17	654-27	654-47

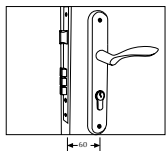

(e) LOCKSET B

CP	BSC	MSC/CP
665-17	665-27	665-47

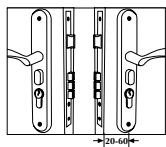

(f) LOCKSET C

CP	BSC	MSC/CP
675-17	675-27	675-47

665-47 OVAL

VITA



(a) HANDLE B2B ONLY

CP	BSC	PB
604-18	604-28	604-08

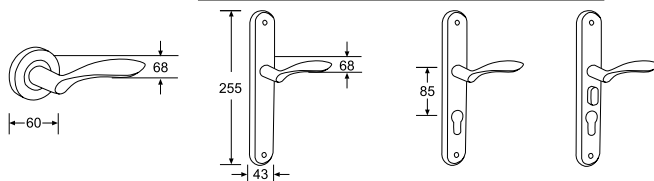

lever a

lever b

lever c

lever d

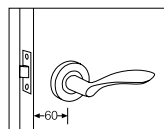

(b) PASSAGE

CP	BSC	PB
614-18	614-28	614-08

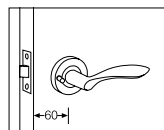

(c) PRIVACY

CP	BSC	PB
634-18	634-28	634-08

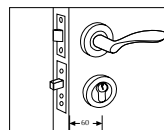

(d) LOCKSET A

CP	BSC	PB
654-18	654-28	654-08

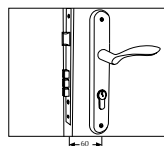

(e) LOCKSET B

CP	BSC	PB
665-18	665-28	665-08

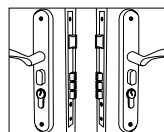

(f) LOCKSET C

CP	BSC	PB
675-18	675-28	675-08

OXLEY



(a) HANDLE B2B ONLY

	CP	BSC
	604-19	604-29

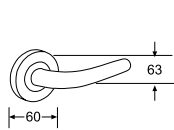

lever a

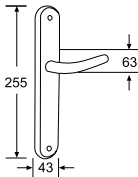

lever b

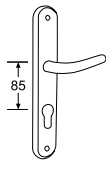

lever c

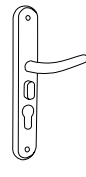

lever d

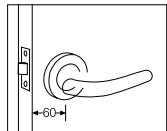

(b) PASSAGE

	CP	BSC
	614-19	614-29

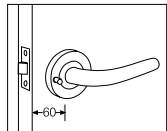

(c) PRIVACY

	CP	BSC
	634-19	634-29

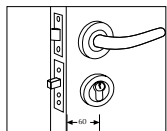

(d) LOCKSET A

	CP	BSC
	654-19	654-29

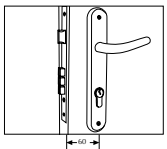

(e) LOCKSET B

	CP	BSC
	665-19	665-29

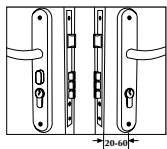

(f) LOCKSET C

	CP	BSC
	675-19	675-29

MILANO



(a) HANDLE B2B ONLY

	CP	BSC
	603-11	603-21

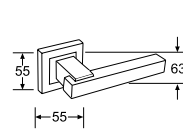

lever a

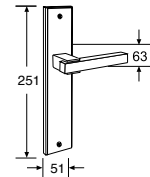

lever b

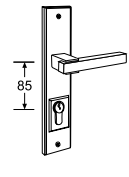

lever c

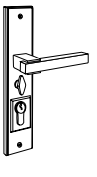

lever d

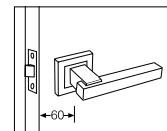

(b) PASSAGE

	CP	BSC
	613-11	613-21

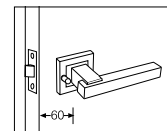

(c) PRIVACY

	CP	BSC
	633-11	633-21

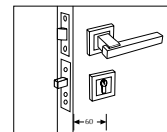

(d) LOCKSET A

	CP	BSC
	653-11	653-21

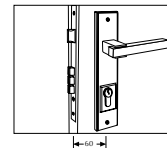

(e) LOCKSET B

	CP	BSC
	669-11	669-21

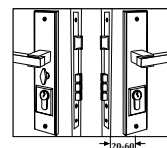

(f) LOCKSET C

	CP	BSC
	679-11	679-21

KENO

VERONA



(a) HANDLE B2B ONLY



(a) HANDLE B2B ONLY

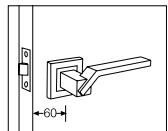
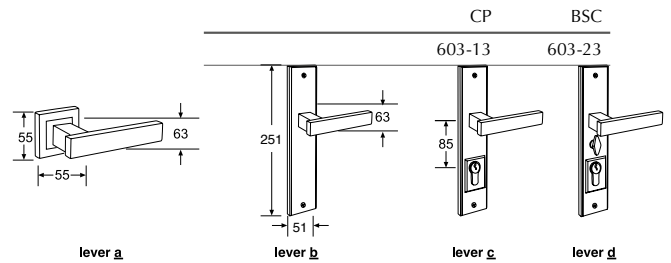
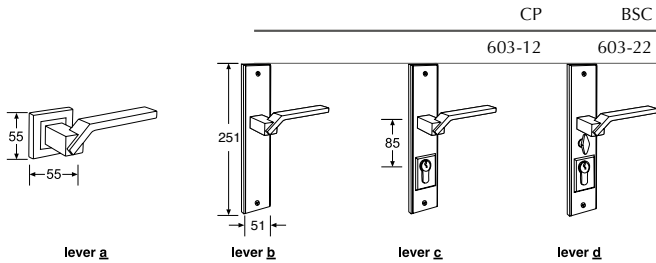

(b) PASSAGE

CP	BSC
613-12	613-22

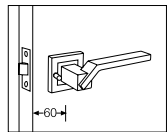

(c) PRIVACY

CP	BSC
633-12	633-22

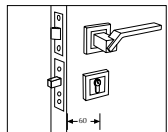

(d) LOCKSET A

CP	BSC
653-12	653-22

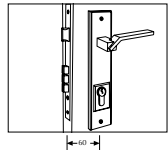

(e) LOCKSET B

CP	BSC
669-12	669-22

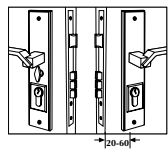

(f) LOCKSET C

CP	BSC
679-12	679-22

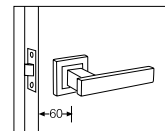

(b) PASSAGE

CP	BSC
613-13	613-23

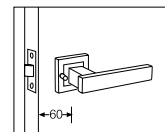

(c) PRIVACY

CP	BSC
633-13	633-23

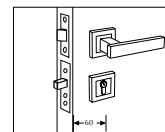

(d) LOCKSET A

CP	BSC
653-13	653-23

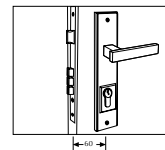

(e) LOCKSET B

CP	BSC
669-13	669-23

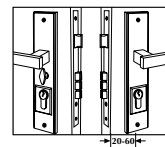

(f) LOCKSET C

CP	BSC
679-13	679-23

VOGUE



(a) HANDLE B2B ONLY

SIZE	PSS	BSS
D60mm	304-14A	304-24A
D54mm	304-14E	304-24E
54x54mm	304-14F	

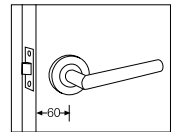
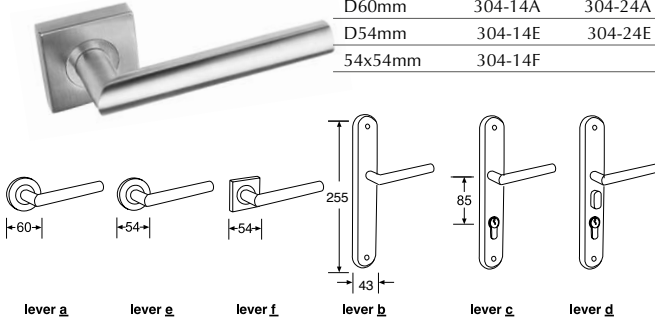

(b) PASSAGE

	PSS	BSS
	314-14A	314-24A
	314-14E	314-24E
	314-14F	

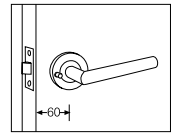

(c) PRIVACY

	PSS	BSS
	334-14A	334-24A
	334-14E	334-24E
	334-14F	

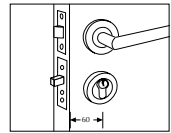

(d) LOCKSET A

	PSS	BSS
	354-14A	354-24A
	354-14E	354-24E
	354-14F	

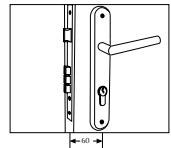

(e) LOCKSET B

	PSS	BSS
	365-14A	365-24A
	365-14E	365-24E
	365-14F	

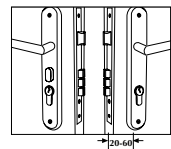

(f) LOCKSET C

	PSS	BSS
	375-14A	375-24A
	375-14E	375-24E
	375-14F	

KELTIC



(a) HANDLE B2B ONLY

	PSS	BSS
	304-16	304-26

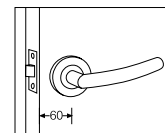
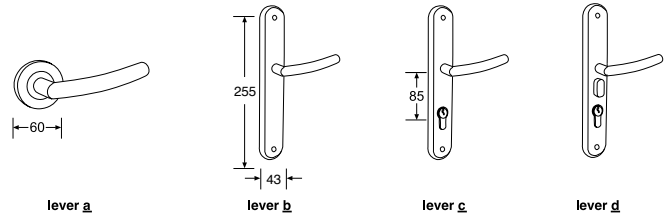

(b) PASSAGE

	PSS	BSS
	314-16	314-26

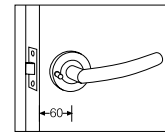

(c) PRIVACY

	PSS	BSS
	334-16	334-26

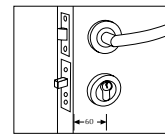

(d) LOCKSET A

	PSS	BSS
	354-16	354-26

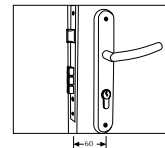

(e) LOCKSET B

	PSS	BSS
	365-16	365-26

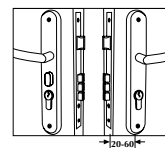

(f) LOCKSET C

	PSS	BSS
	375-16	375-26

REGENT



PSS
304-13

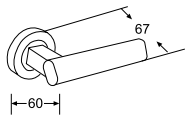

lever a

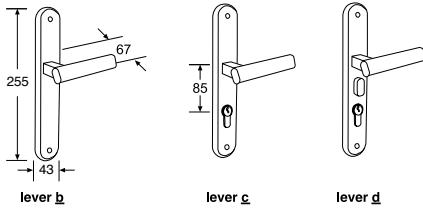

lever b

lever c

lever d

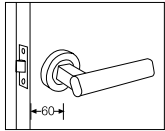

(b) PASSAGE

PSS
314-13

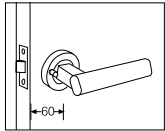

(c) PRIVACY

PSS
334-13

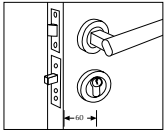

(d) LOCKSET A

PSS
354-13

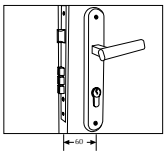

(e) LOCKSET B

PSS
365-13

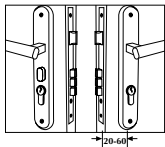

(f) LOCKSET C

PSS
375-13

GLORY



(a) HANDLE B2B ONLY

PSS	BSS
404-11	404-21

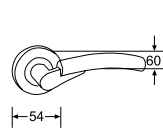

lever a

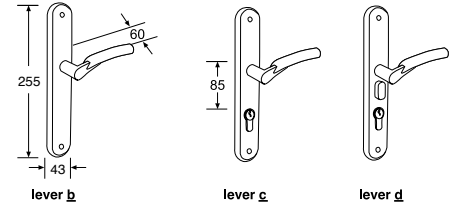

lever b

lever c

lever d

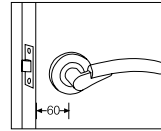

(b) PASSAGE

PSS	BSS
414-11	414-21

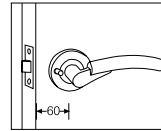

(c) PRIVACY

PSS	BSS
434-11	434-21

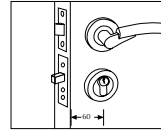

(d) LOCKSET A

PSS	BSS
454-11	454-21

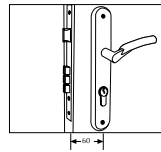

(e) LOCKSET B

PSS	BSS
465-11	465-21

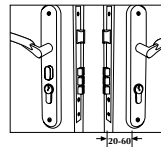

(f) LOCKSET C

PSS	BSS
475-11	475-21

MAX



(a) HANDLE B2B ONLY

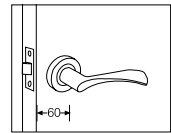
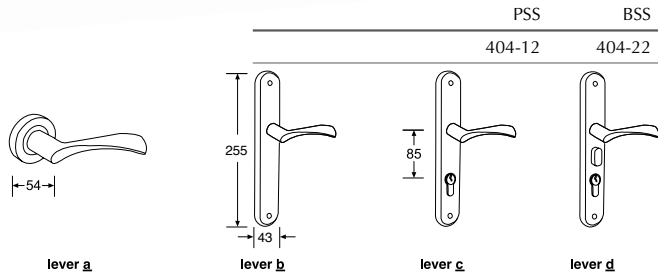

(b) PASSAGE

	PSS	BSS
	414-12	414-22

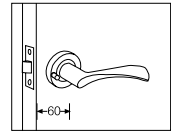

(c) PRIVACY

	PSS	BSS
	434-12	434-22

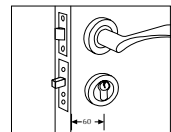

(d) LOCKSET A

	PSS	BSS
	454-12	454-22

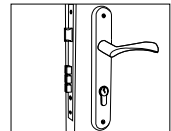

(e) LOCKSET B

	PSS	BSS
	465-12	465-22

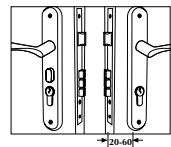

(f) LOCKSET C

	PSS	BSS
	475-12	475-22

SNOWDROP



(a) HANDLE B2B ONLY

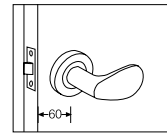
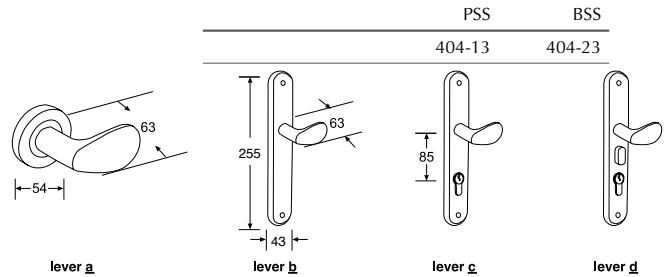

(b) PASSAGE

	PSS	BSS
	414-13	414-23

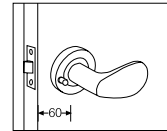

(c) PRIVACY

	PSS	BSS
	434-13	434-23

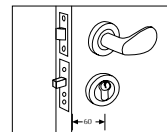

(d) LOCKSET A

	PSS	BSS
	454-13	454-23

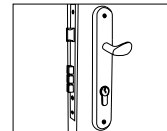

(e) LOCKSET B

	PSS	BSS
	465-13	465-23

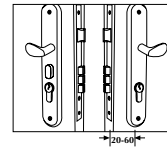

(f) LOCKSET C

	PSS	BSS
	475-13	475-23





a b



c



d



e



f

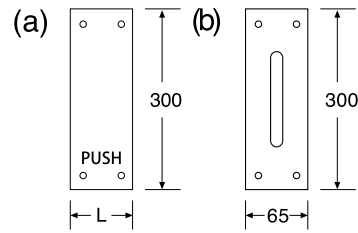

(a) PUSH PLATE

BSS	
SIZE	65X300 911-20
	100X300 911-21
	150X300 911-22

(b) PULL HANDLE ON PLATE

BSS	
SIZE	65x300 911-23

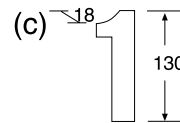

(c)

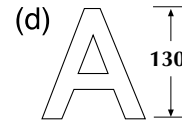

(d)

(c/d) STAINLESS STEEL LETTERS AND NUMBERS

FINISH:PSS/BSS

SIZE:130mm

NUMBERS:0-9

LETTERS:A-D

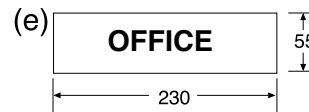

(e)

(e) LETTER SIGNS

FINISH:BSS

SIZE:230x55mm

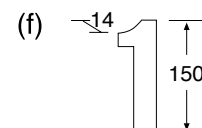

(f)

(f) SOLID STAINLESS STEEL NUMBERS

FINISH:PSS/BSS

SIZE:150mm

NUMBERS:0-9

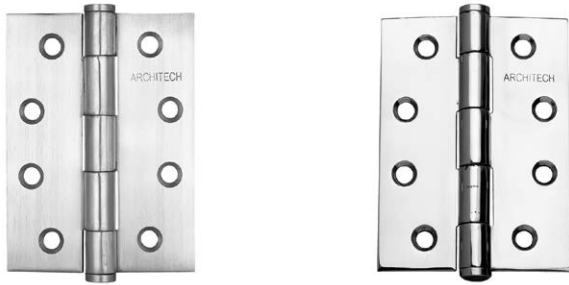

(a) STAINLESS STEEL BUTT HINGE

SIZE	LP/BNB	LP/PSS	LP/BSS	FP/BNB	FP/PSS	FP/BSS
85X60X2.0		812-11	812-22		816-11	816-21
100X75X2.5	812-62	812-12	812-24	816-62	816-12	816-23
100X100X2.5	812-63	812-13	812-25	816-63	816-13	816-24

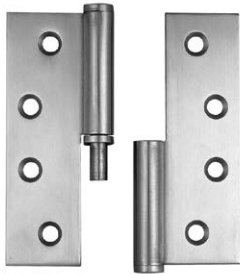

(b) LIFT OFF HINGE

SIZE	BNB	PSS	BSS	PVD
100X75X2.5 LH	811-63	811-13	811-23	811-03
100X75X2.5 RH	811-64	811-14	811-24	811-04



(c) BALL TIP BUTT HINGE

SIZE	LP/PSS	FP/PSS
85X60X2.0	814-11	818-11
100X75X2.5	814-12	818-12
100X100X2.5	814-13	818-13



(d) STAINLESS STEEL BROAD BUTT HINGE FP

SIZE	PSS	BSS
100X125X3.5	817-11	817-21
100X150X3.5	817-12	817-22
100X175X3.5	817-13	817-23
100X200.3.5	817-14	817-24
100X230X3.5	817-15	817-25

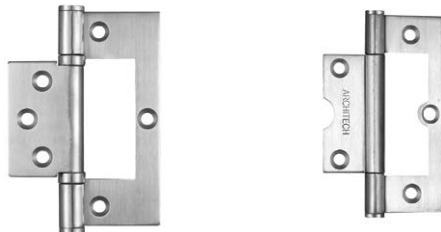

(e) FAST FIT (NON-MORTISE) HINGE WITH BALL BEARING

SIZE	BSS
100X70.8X2.5 TIMBER FRAME	832-22
100X70.8X2.5 METAL FRAME	832-21

(f) FAST FIT (NON-MORTISE) HINGE

SIZE	PVD	PSS	BSS
85x55x2.0 PIN IN CENTRE	835-01	835-11	835-21
85x55x2.0 PIN OFFSET	835-02	835-12	835-22



(a) SOLID BRASS BALL TIP BUTT HINGE

SIZE	FIXED PIN	LOOSE PIN
85X60X2.0		822-01
89X89X3.0		822-02
100X75X3.0	826-03	822-03
100X100X4.0		822-04

(b) SOLID BRASS BUTT HINGE FP

SIZE	
25X19X1.5	820-02
76X41X1.5	820-05
76X51X2.0	820-06
89X89X3.0	820-08
100X60X2.4	820-09
100X75X3.0	820-10

(c) SOLID BRASS BROAD BUTT HINGE FP

SIZE	
100X100X4.0	821-01
100X125X4.0	821-02
100X150X4.0	821-03
100X175X4.0	821-04
100X200X4.0	821-05

(d) PARLIAMONT HINGE FP

SIZE	PB
100X100X4.0	824-01
100X125X4.0	824-02
100X150X4.0	824-03

(e) FAST FIT (NON-MORTISE) HINGE BALL TIP LP

SIZE	PB	CP
75x42.5x1.5	834-01	834-11

(f) HINGE FOR 10mm FRAMELESS SHOWER SCREEN

SIZE	CP
180D-90x115x5.0	821-16
90D	821-17



**BRIGHTON**

BRIGHTON

FINISH: BP/CP/BSC

SIZE: D44x37



**SQUARE**

SQUARE

FINISH: CP/BSC

SIZE: 22x22, 25x25



**CYLINDER**

CYLINDER

FINISH: CP/BSC

SIZE: D16x22, D20x26, D25x30



**ROMA**

FINISH: CP/BSC

SIZE(L/C-C): 150/96, 180/128, 250/160, 280/190, 380/290, 480/390, 590/500



**MILANO**

MILANO

FINISH: CP/BSC

SIZE(L/C-C): 108/96, 140/128, 172/160, 202/190, 236/224, 302/290, 332/320, 402/390, 460/448, 512/500



**BLOCK CABINET HANDLE**

BLOCK CABINET HANDLE

SIZE	CP	BSC
280	229-11A	229-21A
380	229-11B	229-21B
450	229-11C	229-21C
600	229-11F	229-21F

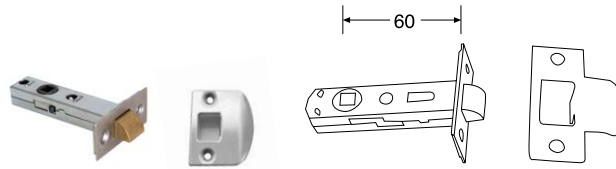

A



B

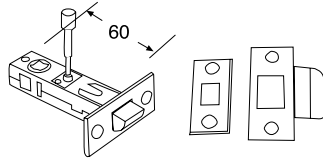

C



D



E



F



G

A. TUBULAR LATCH

SIZE: 60mm BACKSET

FINISHES: BP CP BSC BNB

CODE: 608-03 608-13 608-23 608-63

B. PRIVACY LATCH

SIZE: 60mm BACKSET

FINISHES: BP CP BSC BNB

CODE: 607-09 607-19 607-29 607-69

C. DOUBLE BALL CATCH

SIZE: 60mm BACKSET

FINISHES: BP BNI

CODE: 204-03 204-33

D. MAGNETIC CATCH

SIZE: 60x18x24mm

FINISHES: WHITE BROWN

CODE: 204-06 204-16

E. HEAVY DUTY MAGNETIC DISK CATCH

SIZE: D22mm

FINISHES: BSC

CODE: 608-28

F. ADJUSTABLE BALL LATCH

SIZE: 60mm BACKSET

FINISHES: BP CP BSC

CODE: 608-06 608-16 608-26

G. ADJUSTABLE HEAVY DUTY ROLLER LATCH

SIZE: 53x63mm

FINISHES: PSS BSS BNB

CODE: 608-11 608-21 608-61



A



B



C



D



E

F

RH



G

AUS PATENT

A. MORTISE LATCH LOCK C-C=85mm

SIZE	BP	CP	BSC	BNB
20	640-00	640-10	640-20	640-60
25	640-01	640-11	640-21	640-61
30	640-02	640-12	640-22	640-62
35	640-07	640-17	640-27	640-67
40	640-03	640-13	640-23	640-63
45	640-04	640-14	640-24	640-64
50	640-05	640-15	640-25	640-65
60	640-06	640-16	640-26	640-66

B. REBATE CONVERSION KIT TO SUIT

BP	CP	BSC	BNB
640-09	640-19	640-29	640-69

C. MORTIST LATCH LOCK C-C=47.5mm

SIZE	BP	PSS	BSS
45	640-08	640-18	640-28
57	640-08A	640-18A	640-28A

D. MORTISE HOOK HEAVY DUTY STAINLESS STEEL

BP	PSS	BSS	BNB
645-02	645-12	645-22	645-62

E. STAINLESS STEEL ADJUSTABLE ROLLER BOLT MORTISE LOCK C-C=85mm

SIZE	PSS	BSS	ANT	BNB
45	649-12	649-22	649-42	649-62
60	649-13	649-23	649-43	649-63

F. REBATE CONVERSION KIT TO SUIT

PSS	BSS	ANT	BNB
649-19L	649-29L	649-49L	649-69L
649-19R	649-29R	649-49R	649-69R

G. LONG TONGUE STRIKER(70mm)

PSS	BSS	ANT	BNB
649-16L	649-26L	649-46L	649-66L
649-16R	649-26R	649-46R	649-66R

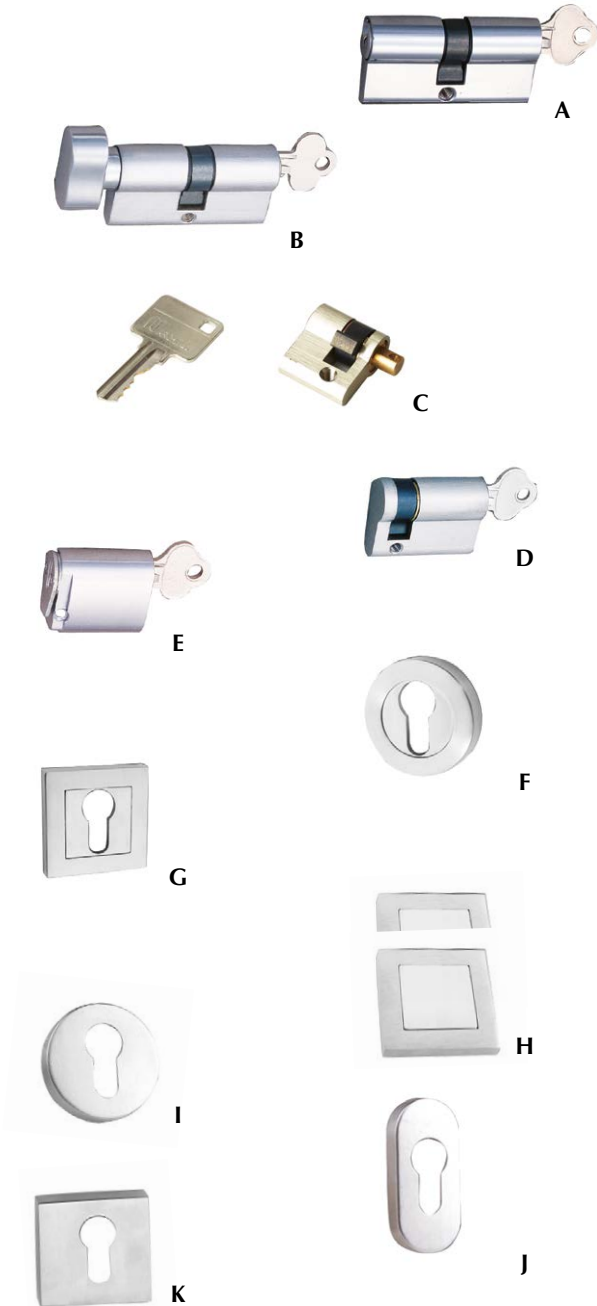

**A. EURO DOUBLE CYLINDER C4**

SIZE	BP	CP	BSC	BNI	BNB
60mm(5 PIN)	641-00	641-10	641-20	641-30	
70mm(5 PIN)	641-02	641-12	641-22	641-32	641-62
80mm(5 PIN)	641-01	641-11	641-21	641-31	
48.4mm(4 PIN)	641-03	641-13	641-23	641-33	641-63
40.4mm(3 PIN)	641-04	641-14	641-24	641-34	641-64

**B. EURO CYLINDER C4 WITH TURN**

SIZE	BP	CP	BSC	BNI
60mm(5 PIN)	643-00	643-10	643-20	643-30
80mm(5 PIN)	643-03	643-13	643-23	643-33

**C. EURO CYLINDER C4 WITH 4.5x4.5 BRASS SPINDLE**

SIZE	BP	CP	BSC	BNB
24.2mm(4 PIN)	643-04	643-14	643-24	643-64
20.2mm(3 PIN)	643-05	643-15	643-25	643-65

**D. EURO SINGLE CYLINDER C4**

FINISH:	BP	CP	BSC	BNI
	642-01	642-11	642-21	642-31

**E. OVAL CYLINDER C4 6 PIN**

FINISH:	BSC
	647-21

**ESCUTCHEON**

SIZE	BP	CP or PSS	BSC	BNI or BSS
F. D53mm EURO KEY HOLE	606-02	606-12	606-22	606-32
D53mm OVAL KEY HOLE	606-01	606-11	606-21	606-31
G. 55x55mm EURO KEY HOLE		606-13	606-23	606-33
55x55mm OVAL KEY HOLE		606-14	606-24	606-34
H. 55x55mm BLIND		606-15	606-25	606-35
I. D53mm EURO KEY HOLE		606-16		606-26
D53mm OVAL KEY HOLE		606-17		606-27
J. 70x32mm EURO KEY HOLE		606-18		606-28
K. 54x54mm EURO KEY HOLE		606-19		606-29



PRIVACY TURN AND EMERGENCY RELEASE (INCLUDING PRIVACY BOLT)

DESCRIPTIONS	FINISH					
	BP	CP	BSC	BNI	BNB	ANT
D57mm ROSETTE	PT50	PT51	PT52	PT53	PT56	PT54
57X57mm ROSETTE	PT70	PT71	PT72	PT73	PT76	PT74



DEAD BOLT SINGLE EURO CYLINDER AND ESCUTCHEON  
AUS & NZ PATENT

DESCRIPTIONS	FINISH					
	BP	CP	BSC	BNI	BNB	ANT
D57mm ROSETTE	DS50	DS51	DS52	DS53	DS56	DS54
57X57mm ROSETTE	DS70	DS71	DS72	DS73	DS76	DS74



DEAD BOLT DOUBLE EURO CYLINDER AND ESCUTCHEON  
AUS & NZ PATENT

DESCRIPTIONS	FINISH					
	BP	CP	BSC	BNI	BNB	ANT
D57mm ROSETTE	DD50	DD51	DD52	DD53	DD56	DD54
57X57mm ROSETTE	DD70	DD71	DD72	DD73	DD76	DD74





KEY IN LEVER HANDLE (PROJECTION SIZE:65mm)

DESCRIPTIONS	FINISH		
	CP	BSC	BNB
D70 ROSETTE	F3021	F3022	F3026



KEY IN LEVER HANDLE AND DEAD BOLT COMBO

DESCRIPTIONS	FINISH		
	CP	BSC	BNB
D70 ROSETTE	G3021	G3022	G3026



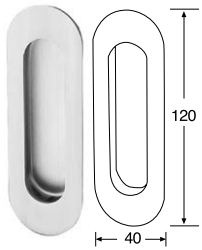

OXFORD-CONCEALED

SIZE	BP	PSS	BSS	ANT	BNB
40x120	601-01	601-11	601-21	601-41	601-61
50x150		601-16	601-26	601-46	601-66

24/34/40

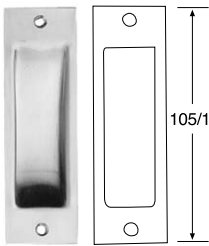

RECTANGULAR SHAPE

SIZE	PSS	BSS
24x105	601-13S	601-23S
34x115	601-13M	601-23M
40x146	601-13L	601-23L

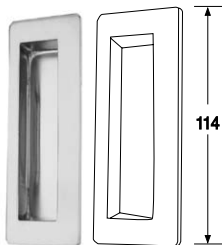

VERONA

SIZE	PSS	BSS	BNS
40x114	601-17	601-27	601-67

40

Depth 13 (Recess Depth11)



KENO

SIZE	PSS	BSS	BNS
50x150	601-15	601-25	601-65

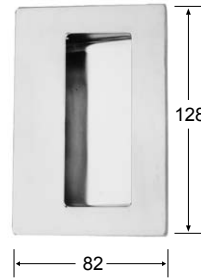

MILANO

SIZE	PSS	BSS
82x128	601-18	601-28



ROUND SHAPE

SIZE	BP	CP	BSC	BNI	ANT	BNB
D30/25	601-04S	601-14S	601-24S	601-34S	601-44S	601-64S
D40/35	601-04M	601-14M	601-24M	601-34M	601-44M	601-64M
D50/45	601-04L	601-14L	601-24L	601-34L	601-44L	601-64L
D60/55	601-04XL	601-14XL	601-24XL	601-34XL	601-44XL	601-64XL



SQUARE SHAPE

SIZE	CP	BSC	BNB
60x60 PERPAIR	SPC71	SPC72	SPC76

(BOLT THROUGH FIXING)



ROUND SHAPE FOR GLASS DOOR

SIZE	PSS
D65/38	601-14G



ELLE

SIZE	PSS	BSS
20x100	226-11	226-21

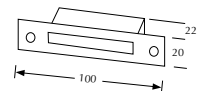



PRIVACY TURN AND EMERGENCY RELEASE (INCLUDING LATCH HOOK)

DESCRIPTIONS	FINISH				
	BP	CP	BSC	BNB	ANT
D60 ROSETTE	SPA60	SPA61	SPA62	SPA66	SPA64
60x60 ROSETTE	SPA70	SPA71	SPA72	SPA76	
TURN ON BOTH SIDES					
D60 ROSETTE	SPB60	SPB61	SPB62	SPB66	SPB64
60x60 ROSETTE	SPB70	SPB71	SPB72	SPB76	



DEAD HOOK WITH EURO SINGLE CYLINDER AND TURN

AUS & NZ PATENT

DESCRIPTIONS	FINISH					
	BP	CP	BSC	BNB	BNI	ANT
FOR 45-55mm THICKNESS DOOR WITH 4 PIN EURO CYLINDER						
D60 ROSETTE	SSA60	SSA61	SSA62	SSA66	SSA63	SSA64
60x60 ROSETTE	SSA70	SSA71	SSA72	SSA76	SSA73	
FOR 35-45mm THICKNESS DOOR WITH 3 PIN EURO CYLINDER						
D60 ROSETTE	SSB60	SSB61	SSB62	SSB66	SSB63	SSB64
60x60 ROSETTE	SSB70	SSB71	SSB72	SSB76	SSB73	



DEAD HOOK WITH DOUBLE EURO SINGLE CYLINDER

AUS & NZ PATENT

DESCRIPTIONS	FINISH					
	BP	CP	BSC	BNB	BNI	ANT
FOR 45-55mm THICKNESS DOOR WITH 4 PIN EURO CYLINDER						
D60 ROSETTE	SDA60	SDA61	SDA62	SDA66	SDA63	SDA64
60x60 ROSETTE	SDA70	SDA71	SDA72	SDA76	SDA73	
FOR 35-45mm THICKNESS DOOR WITH 3 PIN EURO CYLINDER						
D60 ROSETTE	SDB60	SDB61	SDB62	SDB66	SDB63	SDB64
60x60 ROSETTE	SDB70	SDB71	SDB72	SDB76	SDB73	





HEAVY DUTY STAINLESS STEEL CONSTRUCTION MORTISE DEAD HOOK WITH SINGLE EURO CYLINDER

DESCRIPTIONS	FINISH					
	BP	CP	BSC	BNB	BNI	ANT
FOR 45-55mm THICKNESS DOOR WITH 4 PIN EURO CYLINDER						
D60 ROSETTE	SSF60	SSF61	SSF62	SSF66	SSF63	SSF64
60x60 ROSETTE	SSF70	SSF71	SSF72	SSF76	SSF73	
FOR 35-45mm THICKNESS DOOR WITH 3 PIN EURO CYLINDER						
D60 ROSETTE	SSG60	SSG61	SSG62	SSG66	SSG63	SSG64
60x60 ROSETTE	SSG70	SSG71	SSG72	SSG76	SSG73	



HEAVY DUTY STAINLESS STEEL CONSTRUCTION MORTISE DEAD HOOK WITH DOUBLE EURO CYLINDER

DESCRIPTIONS	FINISH					
	BP	CP	BSC	BNB	BNI	ANT
FOR 45-55mm THICKNESS DOOR WITH 4 PIN EURO CYLINDER						
D60 ROSETTE	SDF60	SDF61	SDF62	SDF66	SDF63	SDF64
60x60 ROSETTE	SDF70	SDF71	SDF72	SDF76	SDF73	
FOR 35-45mm THICKNESS DOOR WITH 3 PIN EURO CYLINDER						
D60 ROSETTE	SDG60	SDG61	SDG62	SDG66	SDG63	SDG64
60x60 ROSETTE	SDG70	SDG71	SDG72	SDG76	SDG73	

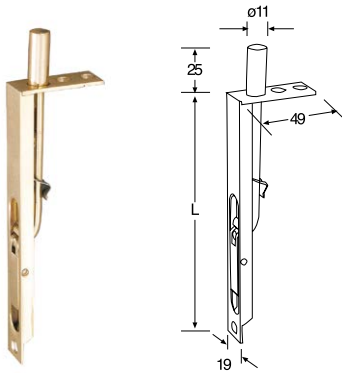

SOLID BRASS FLUSH BOLT (FLIP OVER)

SIZE(mm)	PB	CP
150	903-02	
200	903-03	903-13
300	903-04	903-14
450	903-05	903-15
600	903-06	903-16

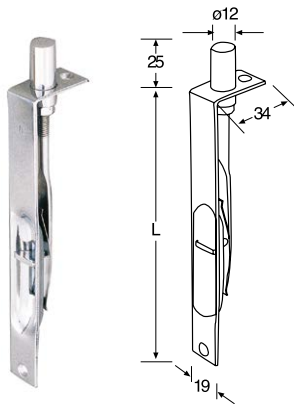

STAINLESS STEEL FLUSH BOLT (SLIDING ACTION)

SIZE(mm)	PVD	PSS	BSS
100	905-01	905-11	905-21
150	905-02	905-12	905-22
200	905-03	905-13	905-23
300	905-04	905-14	905-24

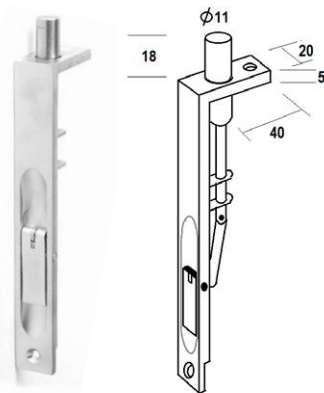

SHEAVY DUTY SOLID BRASS FLUSH BOLT (FLIP OVER)

SIZE(mm)	PB	CP	BSC	BNB
150	906-02	906-12	906-22	906-62
200	906-03	906-13	906-23	906-63
300	906-04	906-14	906-24	
450	906-05	906-15	906-25	
600	906-06	906-16	906-26	906-66

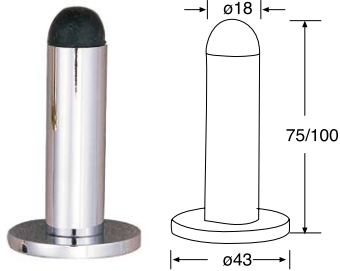

OXFORD

SIZE	BP	CP	BSC	BNB
75mm	511-01	511-11	511-21	511-61
100mm		511-11L	511-21L	511-61L



VOGUE

SIZE	PSS	BSS
75mm	510-12	510-22
100mm	510-12L	510-22L



DOOR STOP WITH HOOK

SIZE	BP	CP	BSC
75mm	514-01	514-11	514-21

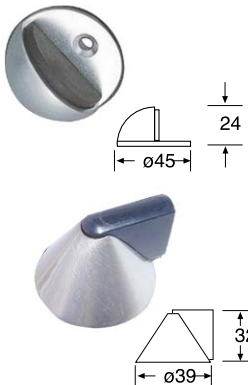

DOME

SIZE	BP	CP	BSC
D45x24mm	520-01	520-11	520-21
SPACER 10mm TO SUIT	520-02	520-12	520-22

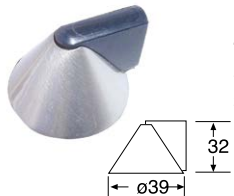

CONE

SIZE	BP	CP	BSC
39x32mm	520-03	520-13	520-23

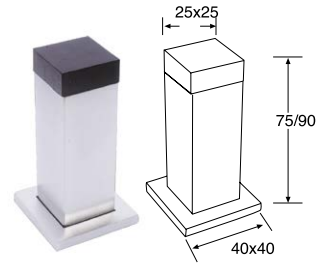

MALANO

SIZE	PSS	BSS
25x25x75mm	515-11	515-21
125x25x00mm	515-11L	515-21L

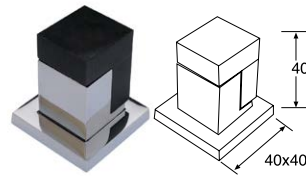

VERONA

SIZE	PSS	BSS
24x24x40mm	520-14	520-24



DOOR STOP HINGE FIT

SIZE	PB	CP	BSC
80-130 DEGREES	540-01	540-11	540-21

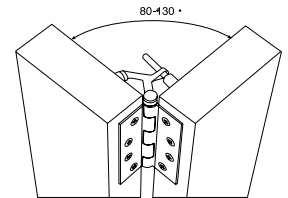

DOOR HOLDER MAGNETIC

SIZE	BP	PSS	BSS
76mm	530-01	530-11	530-21

DOOR HOLDER PLUNGER

SIZE	BP	PSS	BSS
30x152mm	530-02	530-12	530-22
MOVWMENT:30mm			

## INTRODUCTION

Classic Hardware Suppliers Pty Ltd was formed in Melbourne, Australia in 1992. From humble beginnings, we are now recognized as one of the leading suppliers of architectural door hardware and bathroom accessories to the building industry.

As the world is changing, so are we. Our investment into research and development has allowed us to create bold, clear geometric and contemporary designs to meet this challenge. It has always been the philosophy of the company to manufacture and distribute quality products at an affordable price.

Architects, developers and builders specify these products under the brand name of ARCHITEC (ARCHITECH), which is synonymous with quality and performance. We appreciate our achieved success by acknowledging contributions from our customers and business partners.

ARCHITEC products are now sold in a number of countries throughout the world who experience the efforts we continue to improve on.



Please visit our  
Architec products group:  
[www.architec.com.au](http://www.architec.com.au)  
[www.imadesign.com.au](http://www.imadesign.com.au)  
[www.fduck.com.au](http://www.fduck.com.au)