

Vision 8000 Series Rose Furniture

Die cast zinc

The dormakaba Vision 8000 series of door furniture is a high quality cost effective range of handles for light commercial and domestic applications.

It is well suited for residential applications where aesthetics and contemporary appeal is desired.

Lever handles are fitted onto a 53mm rose mounting plate which has a slim 10mm projection of the door face. The Vision 8000 is constructed using a die cast rose and lever and is designed to suit dormakaba mortice locks and latches but can be equally compatible with other Australian mortice locks and tubular latches.

Dimensions

Round rose: 53mm diameter rose, 10mm thick with 41mm fixing centres.

Square rose: 57mm x 57mm, 10mm thick with 41mm fixing centres.

Fixings

Designed with a through fixing and perforated screws to allow a quicker installation. Fixings can be in a horizontal or vertical pattern.

Handing

Roses are non-handed and in most cases can be reversed (refer to lever designs for more information).

Fire Rating

Vision 8000 series furniture is fire rated and comply with AS1905.1.

 - The Vision 8000 series door furniture has been tested on fire door assemblies in accordance with Australian Standards. Please refer to fire door manufacturer for specific approved details.

Disabled Access Compliance

A selection of lever handle designs comply with AS1428.1 2009.



- Compliant levers are shown with this symbol next to the lever handle design.

Functions

Passage/standard- sold as a pair including spindle and fixing screws less latch.

Privacy - sold as a pair including spindle, fixing screws and a 60mm backset privacy latch.

Fixed Lever - half set levers can be fixed with the use of a SP8000-014 fixed spindle backing plate which can be purchased as an optional accessory.

Finishes

Satin Chrome	SX
Polished Chrome	PC
Black	BLK

The Vision 8000 series is also available with privacy button on round rose and square rose



Vision 8000 Series

Round Rose

8300/1

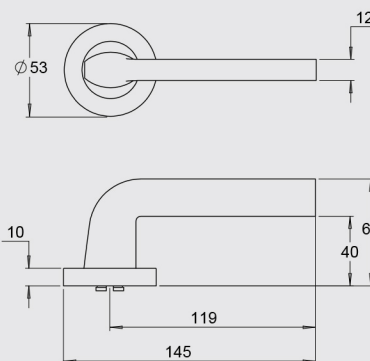

8300/6

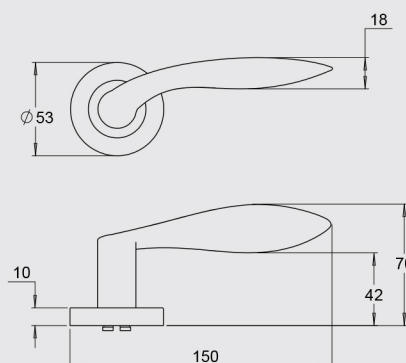

8300/8

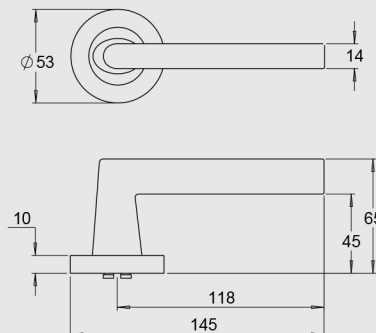

8300/9

