

# Vision 8600 Series Rose Furniture

## Die cast zinc

The dormakaba Vision 8600 series retro range of door furniture is a high quality cost effective range of handles for light commercial and domestic applications.

It is well suited for residential applications where aesthetics and contemporary appeal is desired. It is ideal for retrofitting in place of existing door fittings due to its larger diameter rose. Levers are fitted onto a 65mm rose mounting plate which has a slim 10mm projection of the door face.

Vision 8600 series retro is constructed using a die cast rose and lever and is designed to suit dormakaba passage mortice locks and tubular latches but can be equally compatible with other Australian tubular latches.

### Dimensions

65mm diameter rose, 10mm thick with 41mm fixing centres.

### Fixings

Designed with a through fixing and perforated screws to allow a quicker installation. Fixings can be in a horizontal or vertical pattern.

### Handing

Roses are non-handed and in most cases can be reversed (refer to lever designs for more information).

### Fire Rating

Vision 8600 series retro furniture is fire rated and comply with AS1905.1.

 - The Vision 8600 series door furniture has been tested on fire door assemblies in accordance with Australian Standards. Please refer to fire door manufacturer for specific approved details.

### Disabled Access Compliance

A selection of lever handle designs comply with AS1428.1 2009.

 - Compliant levers are shown with this symbol next to the lever handle design.

### Functions

Passage/standard- sold as a pair including spindle and fixing screws less latch.

Privacy - sold as a pair including spindle, fixing screws and a 60mm backset privacy latch.

Fixed Lever - half set levers can be fixed with the use of a SP8000-014 fixed spindle backing plate which can be purchased as an optional accessory.

### Finishes

Satin Chrome	SX
Polished Chrome	PC
Black	BLK

# Vision 8600 Series

## Round Rose

8600/10

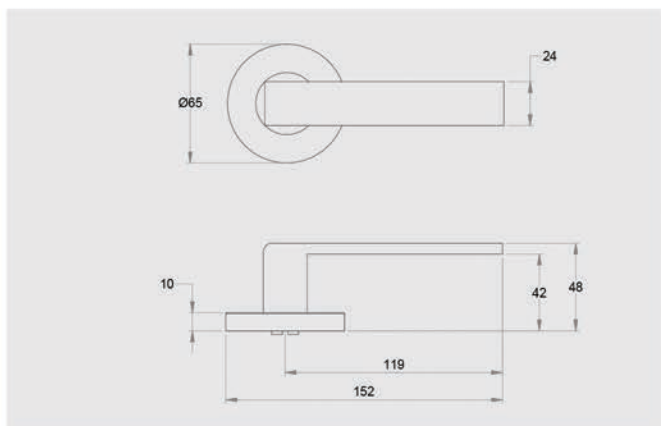

8600/12

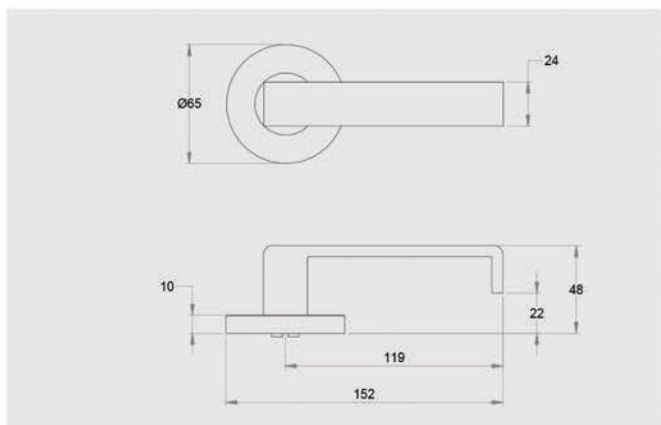

8600/14

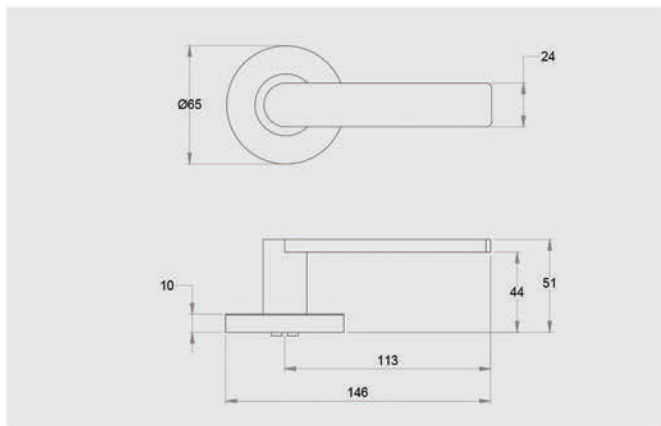

8600/16

