



HB 527

HB 525

HB 525

STAIR RAIL BRACKETS WITH WIRING CAPABILITY

The Halliday + Baillie HB 525 has been developed from the HB 520 Bracket. The HB 525 incorporates a channel in both the body and upstand allowing for wiring to connect to LED lighting strips.

The HB 525 - HB 528 brackets come in both wiring capable and 'blank' versions and are still suitable for use with 40mm to 50mm diameter rails.

Projection from wall (offstand) : 100mm

Overall height (upstand) : 75mm

Includes all fasteners including anchor for concrete, masonry or wood framed plasterboard walls. Epoxy not included. (please contact your local H + B dealer for further information).

Material : non-anodized aluminium alloy

Recommended Spacing : 600-800mm

Available in all standard finishes except "BN" Brushed Nickel. See finishes sheet for further details.

Glass fixing kits not available for styles HB 525, HB 526, HB 527 and HB 528.

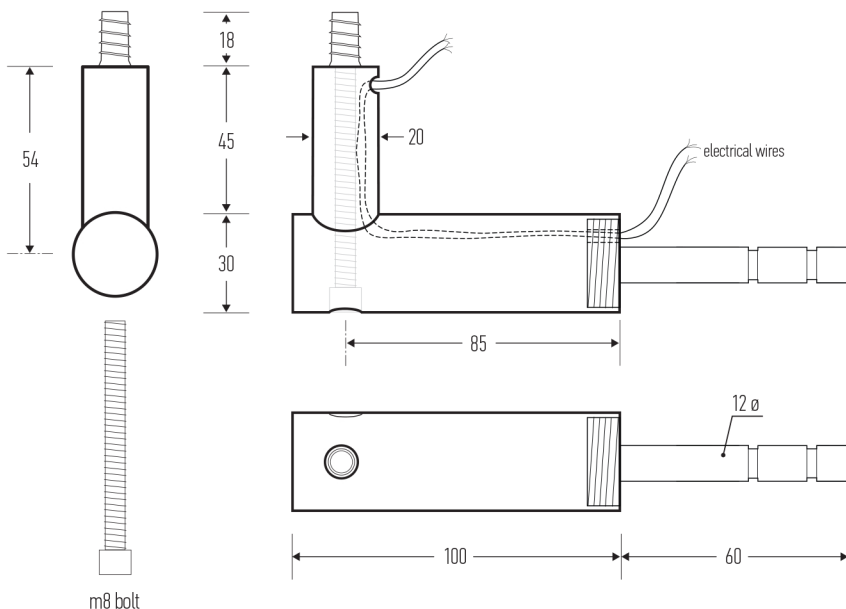

Halliday + Baillie brackets are tested in accordance with both the AS/NZS 1170.1:2002 (Structural Design Actions) standards and the International Building Code, IBC (2003) to comply with the 200lb fall rating.

Designed and manufactured in New Zealand. For more information, installation templates, and measured drawings of this product and others please visit : www.hallidaybaillie.com or contact your authorized Halliday + Baillie dealer. All information subject to change.

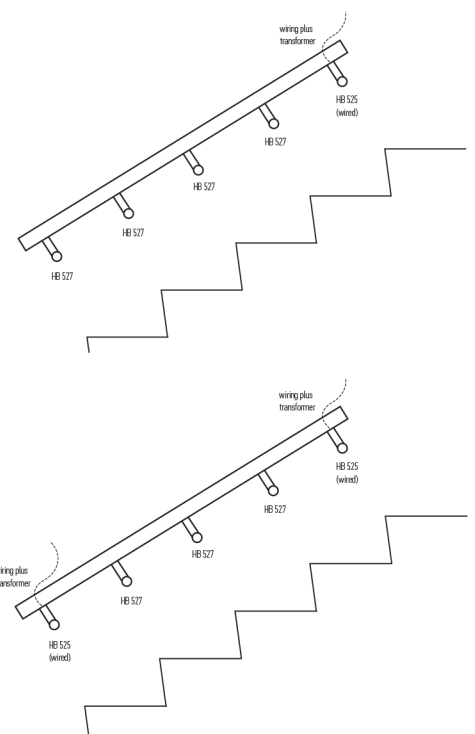

ELECTROPLATED

Electroplating is done by passing an electric current through a chemical solution that contains various metals plus the objects being plated. The current causes the metal in the solution to be attracted to the object and bond with it. The finishes listed all have several layers and processes of plating, and can be bonded to a variety of base metals including steel, stainless steel, brass, copper, zinc and aluminum.



BN : Brushed Nickel. Our brushed nickel finish undergoes several stages for a classic finish and superior durability. As with most of our zinc hardware, a base of several copper layers are plated first followed by a two-step nickel process. The first layer is a bright sulphur free nickel for corrosion resistance. This is followed by a second pearl bright satin nickel layer to achieve our characteristic velvet look. When the two layers are present a higher corrosion resistance is achieved than just the semi-bright layer on its own. After coating the items are brushed for a finish which is a match to most satin or brushed stainless steel items.

ORB : Oil Rubbed Bronze. Multiple layers of copper, nickel and brass plating are required to achieve our Oil Rubbed Bronze finish. The final surface is hand burnished with oil and a hand laid wax process which will gracefully wear over time. The surface is then wiped with wax. This process is considered a 'living finish' and will patina over time and with different weather conditions. This is not considered a flaw in the process but rather, a desirable characteristic of the continuous aging process of this material. Exact colour matching is not guaranteed between batches.

KC : Matt Black Chrome. To achieve our soft flat black, items are plated to the same level as our "Brushed Nickel" but without the brushing stage. Items undergo an additional plating step in a black chrome bath which gives added protection and a deep black finish, before being hand waxed to provide surface consistency and to minimise finger printing on the surface when new. Please note that the wax on these items will gracefully wear away over time.

PB : Polished Brass (unlacquered). To achieve this finish a thick layer of brass is electrodeposited on the article after the same multiple copper and nickel plating process is undertaken as with our Brushed Nickel. These additional layers provide heightened durability and protect the base metal. After brass plating, items are brushed to a high polish. On dispatch items are a bright mirror brass without further coating or lacquer, and are considered a 'living finish'. The surface of items will dull and patina over time and with different weather conditions if not kept polished. This is considered a desirable characteristic in the aging process of unlacquered brass.

PC : Polished Chrome. Our bright/polished chrome finish undergoes the nickel process as detailed in "Brushed Nickel". After the polishing step, articles are plated with a heavy chrome barrier layer, and finally polished to a high mirror shine.

SC : Satin Chrome. To achieve this finish a special pearl bright satin nickel plating process is used. Additives to the final nickel layer cause the plating process to produce a velvet/satin result that is then over-plated with a chrome layer. This smooth velvet finish is ideal for both interior and exterior use, where superior durability is required.

POWDER COATED

The standard Halliday + Baillie powder coat colours are applied electrostatically, then cured under highly controlled temperatures to allow it to form a robust 'skin'. Powders can be thermoplastic or thermoset polymer and are used to create a hard finish that is tougher than a conventional paint.

Unlike anodised or electroplated finishes Electro™ powder coatings can be applied to an even wider variety of substrates. Electro™ finishes are highly durable and made from UV resistant materials with no liquid chemicals, solvents or caustic solutions used in their manufacture. The Electro™ powder coatings also have a negligible VOC content and are suitable for a range of climatic conditions, from hot to cold and humid to dry. Importantly the Electro™ range has excellent colour retention and is suitable for use in projects further than 10 metres from salt water making it a superior choice for coastal environments.



EBA : Electro Black Ace. This finish has one of the lowest gloss levels we have seen in a powder coat. Along with its opposite Electro Flat White, this finish has a matt appearance, ideal for subtly blending into dark cabinetry or doors.

EDB : Electro Dark Bronze. This finish has a pearlescent or metallic content rather than a standard flat paint finish, providing a more 'metal' look than standard powder coats. The Electro Dark Bronze is also a good alternative to full black where a slightly softer approach is required.

EMB : Electro Medium Bronze. Like the darker finish above, the Medium Bronze has a pearlescent or metallic finish that sets it apart from standard flat paint powder colours. The lighter tone of this finish matches more closely to traditional aged brass finishes, without the issues of colour matching between batches, or the changing patina inherent in living finishes. This is a great option where the look of bronze is required, but not the variability of colour.

EFW : Electro Flat White. This is the most matt of all the powder coated finishes, and has a soft matt texture. While we do keep small stocks of product in Electro Flat White additional lead times may apply for this finish.

WHT : Appliance White. A good match to RAL 9016 Traffic White, this finish has a higher gloss level than our other powder coated finishes, and true to the traditional powder coat look.



SOLID BRASS (D Pull Series Only)

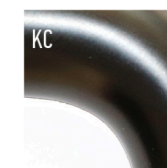
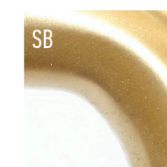
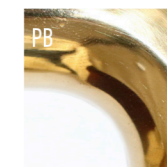

All of our D Pull range is bent or milled from solid brass bar for optimum quality and to ensure elegant aging over time. Our brass is sourced in New Zealand and is RoHS certified to meet international standards. All of our D Pulls are shipped without any additional coatings or lacquer. With the exception of the Black Chrome, all pulls are therefore a "living finish" and will age and patina over time.

AB : Aged Brass. To get the traditional look (often called 'Tuscan Brass'), solid brass bars undergo an oxidising process to give a darkened look which is then hand burnished and waxed to seal the finish. Please note that the wax on these items will gracefully wear away over time as the handle patinas.

PB : Polished Brass. After bending and/or milling, handles are hand polished to a mirror finish. On dispatch this finish is a bright mirror brass without further coating or lacquer, and is considered a 'living finish'. The surface will dull and patina over time and with different weather conditions if not kept polished which is considered a desirable characteristic in the aging process of brass.

SB : Satin Brass. After bending and/or milling, handles are given a light hand polish to remove any surface inconsistencies, then hand sateened to give a soft lustre. As with the Polished Brass pulls, this is a 'living finish', and the surface will dull and patina over time and with different weather conditions if not kept polished. This is considered a desirable characteristic in the aging process of brass.

KC : Black Chrome. Similar to the standard black chrome the brass is double coppered, followed by a fine layer of bright nickel and a layer of satin nickel before brass plating. An additional plating step in a black chrome bath gives added protection and a deep black finish, before being hand waxed to provide surface consistency and to minimise finger printing on the surface when new. Please note that the wax on these items will gracefully wear away over time.

BSC : Brushed Satin Chrome. To achieve this finish a special pearl bright satin nickel plating process is used as per the standard Satin Chrome finishes including the twin nickel layers. The resulting velvet/satin result is then over-plated with heavy chrome and finely brushed before assembly. This finish is only available for orders of 30 or more of the same product.

PN : Polished Nickel. Our bright/polished nickel finish undergoes the same process as detailed in "Brushed Nickel". After coating however, the items are polished to a high shine mirror finish rather than brushing. This finish is only available for orders of 30 or more of the same product.

BULK ONLY

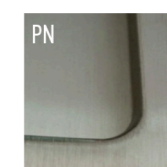

These finishes are available in minimum quantities only. Please contact your local Halliday + Baillie representative for further information.

OTHER – STAIR BRACKETS

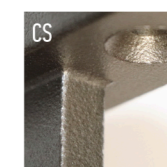
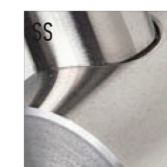

Our wide range of brackets are made from aluminum, 316 stainless steel, and raw gunmetal bronze. Please note that the HB 510 is a bead blasted stainless steel finish, and the HB 526, HB 528, and HB 530 are all milled stainless steel (more of a match to brushed stainless steel). All aluminum brackets come in Satin Chrome as standard. The following brackets can also be coloured with most of our Electroplated and Powder Coated finishes – HB500, HB520, HB525, HB527, HB540 and HB595. The HB550, HB560, and HB570 styles can be coloured to SC only. All finishes other than SC, BS/SS, CS and RB are done to order and may have additional lead times.

SC : Satin Chrome. Although plated onto a solid milled aluminum base rather than on zinc, this finish is achieved with the same special pearl bright satin nickel plating process as the standard Satin Chrome on our flush pulls and lock sets. Additives to the twin nickel layers cause the plating process to produce a velvet/satin result that is then over-plated with heavy chrome. All brackets are available in this finish as standard.

SS : Brushed Stainless Steel. This is a mill finish on 316 marine grade stainless steel and is available on the HB526, HB528, and HB530 brackets only. After precision CNC cutting, the surface is finely brushed to give the characteristic stainless steel sheen. These brackets are ideal for use outside, and where additional durability is required.

CS : Cast Stainless Steel. Unlike our other 316 marine grade stainless steel brackets, the HB510 is cast rather than milled. After casting, the components are bead blasted to give a textured industrial feel. This bracket is also ideal for use outside and where a additional durability and a tough aesthetic is needed.

RB : Raw Bronze. After precision CNC cutting from blocks of solid bronze, the surface is very finely brushed. This is a 'living finish' and the surface will dull and patina over time and with different weather conditions if not kept polished. Given the high copper content of bronze, in exterior situations these brackets may attain the Verdigris look common to aged copper. This is not considered a fault but rather a desirable characteristic of this material.

■ Please check with your local Halliday + Baillie representative as not all finishes are available in all regions. Halliday + Baillie sliding door hardware is available in the following durable high-quality finishes.